

## REDUCING THE EFFECTS OF POWER AMPLIFIER NONLINEARITIES IN MODERN COMMUNICATION SYSTEMS

\*Roman MARŠÁLEK, \*Vladimír ŠEBESTA

\* Institute of Radio electronics, Brno University of Technology, Purkyňova 118, Brno, Czech Republic,  
email: marsaler@urel.fee.vutbr.cz, sebesta@urel.fee.vutbr.cz tel : +42 5 41149156

### SUMMARY

*This paper is focusing on the non-desirable effects of the nonlinearity of power amplifiers in new generations of wireless communication systems, like GSM-EDGE or HIPERLAN/2. The criteria used for evaluation of these effects like EVM or ACPR are described and their simulated values are presented.*

*Second part of this paper deals with one of the basic methods for nonlinearities reducing - digital baseband adaptive predistortion. Paper shows the influence of the predistortion method to EVM, signal spectrum etc.*

**Keywords:** digital predistortion, EDGE/8-PSK

### 1. INTRODUCTION

New wireless communication systems like GSM-EDGE or HIPERLAN/2 use modern digital modulation techniques like 8-PSK (EDGE) or OFDM (HIPERLAN/2). These types of modulations are more sensitive to non-desirable effect of high-frequency power amplifiers, which cause spectral regrowth or increasing of bit-error-rate (BER).

There are a lot of methods (analog or digital) to reduce these effects of nonlinearities, in this paper we deal with one of them – digital adaptive predistortion.

### 2. FORMULATION OF THE PROBLEM

GSM-EDGE is a system of 2.5-th generation for mobile communications. Higher bit rates which offers are allowed by using rotated 8-PSK modulation. The vector diagram of EDGE/8-PSK signal after shaping filter is shown in Fig. 1.

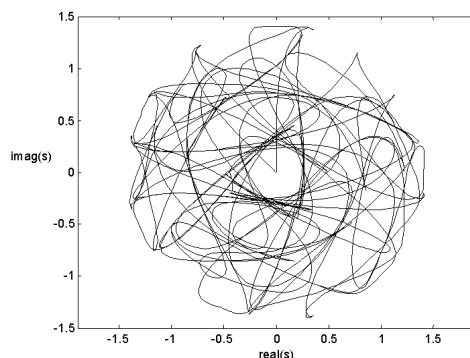

**Fig.1** Vector diagram of EDGE signal

HIPERLAN/2, a system for new generations of wireless local area networks, uses on the contrary OFDM modulation. Allowed bit rates are from 6 to 54 Mb/s what is maintained using different coding

scheme (BPSK, QPSK, 16QAM or 64QAM) and bit puncturing. As all OFDM-based systems, it suffers from high Peak-to-Average-Power-Ratio (PAPR) which makes it very sensitive to amplifier nonlinearities. For illustration, the amplitude histogram of HIPERLAN/2 signal is shown in Fig. 2.

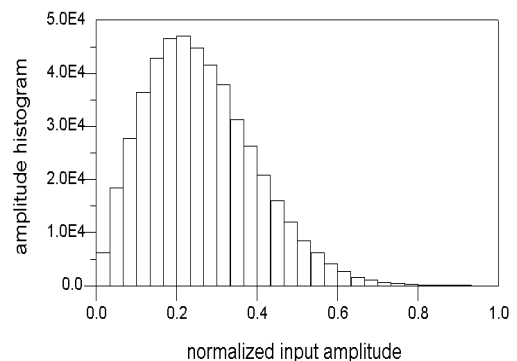

**Fig.2** Amplitude histogram of HIPERLAN/2 signal

### 3. CHARACTERIZATION OF NONLINEARITIES

These main parameters are used to characterize the impact of nonlinearities to digital communication systems:

- EVM (Error Vector Magnitude)
- ACPR (Adjacent Channel Protection Ratio)
- Power spectrum
- BER (Bit Error Rate)

EVM characterizes the in-band distortion. For its calculation, the definition from equation (1) can be used.

$$EVM (rms) = \sqrt{\frac{1}{N} \sum_{k=1}^N |E(k)|^2} \quad (1)$$

where  $N$  is a number of symbols used for EVM calculation and  $E(k)$  is error vector – difference between demodulated complex symbol and ideal transmitted complex symbol.

Adjacent channel protection ratio is defined as :

$$ACPR_{eft} = 10 \log_{10} \left( \frac{\int P_{AdjacentChannel}}{\int P_{MainChannel}} \right) \quad (2)$$

In fig. 3 and 4, examples of ACPR and EVM as functions of input mean power for the HIPERLAN/2 system are shown.

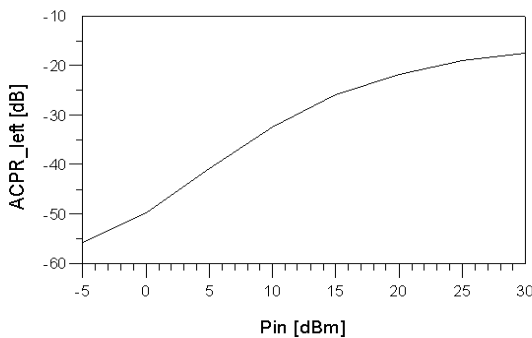

Fig.3 ACPR to input mean power for HIPERLAN/2

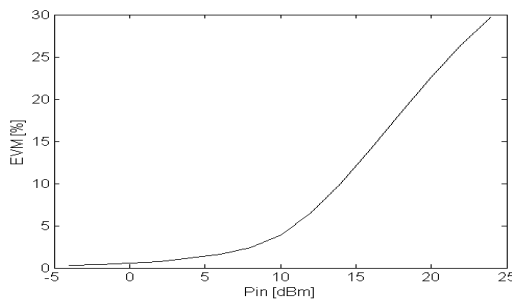

Fig.4 EVM as a function of input mean power for HIPERLAN/2

#### 4. PA MODEL

During our simulations, classical AM/AM and AM/PM characteristics was used to describe a nonlinear behavior of power amplifier. The disadvantage of this way of characterization is in its incapability to describe memory effects of PA and also its frequency dependency, so in further work, some more complex PA model (possibly based on Volterra series) will be used. In Fig. 5 the example of AM/AM and AM/PM characteristics for LDMOS PA is shown.

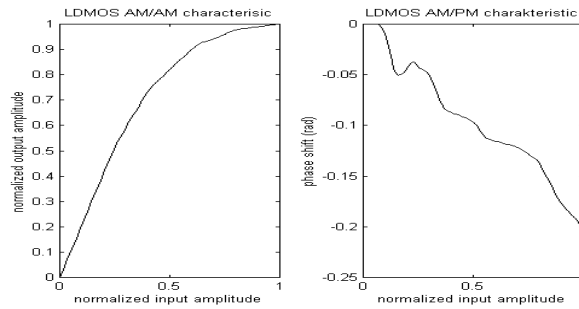

Fig.5 AM/AM and AM/PM of LDMOS PA

#### 5. DIGITAL PREDISTORTION PRINCIPLE

Using predistortion, the amplifier non-linearity is compensated by predistorting device which has inverse characteristics of the amplifier being linearized. Thus overall characteristics of predistorter and power amplifier are linear. The parameters of PA can change in time due to the aging of devices, changes of supply voltage, changes of temperature etc. So the predistorting device must be adaptable to PA parameters changes. In such case we speak about Adaptive predistortion. The idea of digital adaptive predistortion is shown in Figure 6.

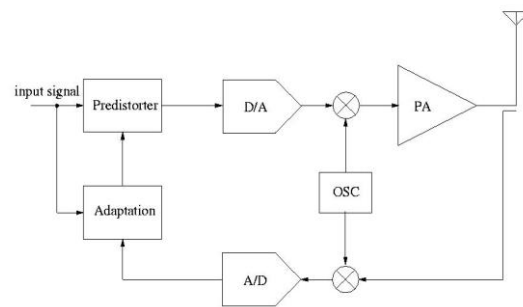

Fig.6 Digital adaptive predistortion principle schematic

#### 6. ADAPTATION ALGORITHM

Our described predistorter is implemented as look-up-table with small number of points with linear interpolation of the values in between presented points. There are another possibilities which can be used (for example polynomial predistortion).

The predistorter's function can be described by these equations :

$$A_p = A_i \cdot r \quad (3)$$

$$\phi_p = \phi_i + \psi \quad (4)$$

where  $A_i, A_p, \phi_i, \phi_p, r, \psi$  are predistorter (PD) input amplitude, PD output amplitude, phase at PD input, phase at PD output, predistorter gain and its phase correction, respectively. The goal of adaptation algorithm is to minimize the errors between desired  $(K \cdot A_i, \phi_i)$  and actual downconverted  $(A_d, \phi_d)$

amplifier output amplitude and phase, where  $K$  is desired PA gain. The adaptation process can be characterised by these equations:

$$r_{t+1} = r_t + \mu \cdot E_a \cdot \frac{r_t}{A_d} \cdot \Delta \quad (5)$$

$$\psi_{t+1} = \psi_t + \mu \cdot E_\phi \cdot \Delta \quad (6)$$

where index  $t$  is used for values in current adaptation step, and  $t+1$  denotes new calculated values.  $\mu, E_a, E_\phi$  is the convergence constant, amplitude and phase error, respectively. Proportional factor  $\Delta$  is used for weighting the correction of the LUT point proportionally to the distance between actual input amplitude and point which is adapted. This is illustrated in fig. 7.

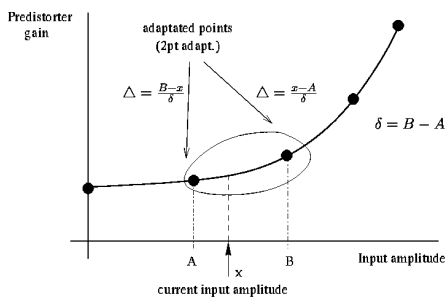

Fig.7 Illustration of proportional factor

## 7. DEMONSTRATION SOFTWARE

To allow to study the predistortion principle and its effects on nonlinearity of PA, a demonstration software in MATLAB environment was created. User can choose from different types of PA (now LDMOS, TWT amplifier), can change number of points in predistorter's table, number of iterations used for adaptation, convergence constant, etc. Results are in the form of power spectrum, amplitude and phase error between actual and ideally amplified signal, constellation diagram and EVM.

GSM-EDGE modulated signal was generated according proposal [1]. Bits (in real system generated by higher layers) are modulated using 8-PSK scheme and then they are  $3\pi/8$  rotated and shaped by pulse shaping filter (linearised GMSK pulse). Such constructed signal is then passed through model of PA. Its output signal is filtered by receiving filter (overall response of transmitting and receiving filter is raised cosine, so ideally there is no intersymbol interference),  $3\pi/8$  derotated and 8-PSK demodulated.

## 8. PREDISTORTION SIMULATION RESULTS

In Fig. 8, the effectivity of described adaptive predistortion is demonstrated to reduce out-of-band

signal spectrum for EDGE/8-PSK signal (simulated with convergence constant equal to 0.5, 800

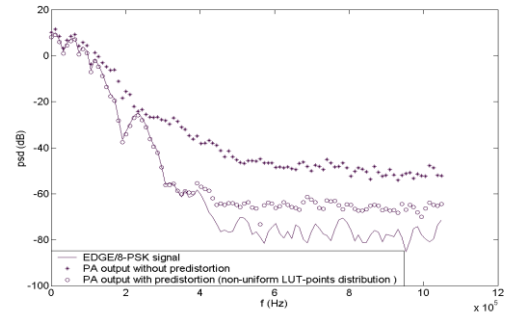

Fig.8 Spectrum of EDGE/8-PSK signal with and without predistortion

iterations and 19 points in the predistorters table).

EVM calculated on 150 points of demodulated signal (after receiving filter and  $3\pi/8$  derotation) as a function of number of iterations for adaptive process is shown if fig. 9. It can be seen that after 300 iterations, EVM is reduced to the value less than 1%. Constellation diagrams for 50 and 200 iterations are shown for illustration if fig. 10.

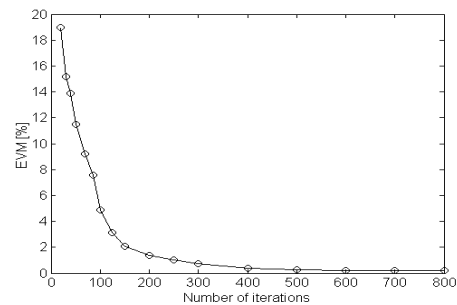

Fig.9 EVM of demodulated EDGE signal as a function of number of iterations

During the simulation, a possibility to simplify the adaptation algorithm was also examined, so in the equations (5) and (6) the terms

$$E_a \cdot \frac{r_t}{A_d} \cdot \Delta$$

and

$$E_\phi \cdot \Delta$$

were replaced by their signs only – it gives simpler predistorter adaptation algorithm, but the time of adaptation is strongly prolonged (convergence constant must be smaller – value of 0.005 was used).

Relative gain error for two types of adaptation – non-reduced proportional adaptation of two points according (5) and (6), and adaptation using sign function is shown as a function of number of iteration in fig. 11

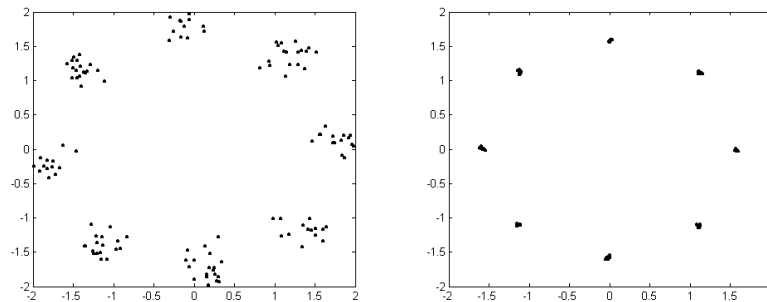

**Fig.10** Constellation diagrams of predistorted and amplified EDGE signal for 50 (left) and 200 (right) iterations

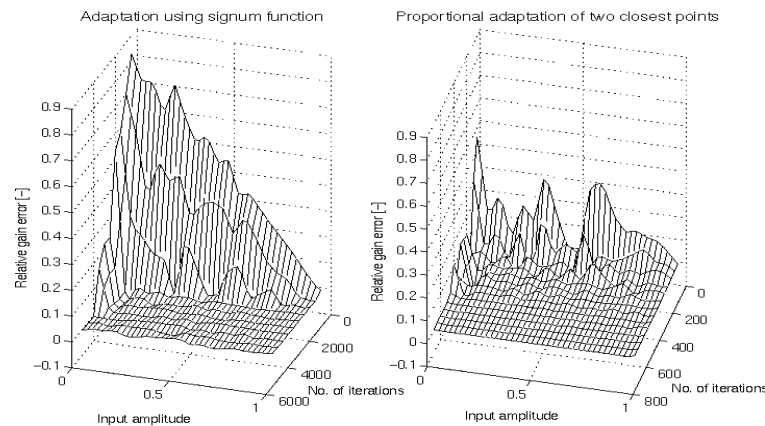

**Fig.11** Rel. Gain error for the case of proportional adaptation (right) and simplified adaptation using signum function (left)

## 9. CONCLUSIONS

In this paper, the reducing of undesirable nonlinear effects of power amplifiers using digital adaptive predistortion was demonstrated for the case of EDGE/8-PSK signal. Program for the predistortion demonstration created in MATLAB environment was briefly described and from the results obtained using this software, it was shown that both in-band (characterized by EVM) and out-of-band (characterized by signal spectrum) distortion can be reduced

### Acknowledgement

This work was supported by the Ministry of Education, Youth and Sports of the Czech Republic project "Linearizace vř vykonovych zesilovacu s ohledem na uplatneni v GSM-EDGE".

## REFERENCES

- [1] Digital cellular telecommunication system (Phase 2+) Modulation, Draft ETSI EN 300 959, v.8.1.2 (2001-02).
- [2] Broadband Radio Access Networks (BRAN), HIPERLAN Type 2, Physical layer, ETSI TS

101 475 v 1.1.1 (2000-04)

- [3] Zavosh, F., Thomas, M., Thon, Ch., Hall, T., Artusi, D., Anderson, D., Ngo, D., Runton, D. Digital Predistortion Techniques for RF Power Amplifiers with CDMA Applications, Microwave Journal, October 1999.

## BIOGRAPHY

Vladimř Šebesta was born in Předřn, Czech Republic. He received the M.Sc. degree in electrical engineering from the Czech Technical University, Prague, in 1961 and the Ph.D. degree from the Brno University of Technology in 1974. His research interests include the general areas of statistical signal processing and digital communications. Currently, he is a Professor with the Brno University of Technology, Czech Republic. Prof. Šebesta is a Member of the IEEE.

Roman Marřálek was born in Brno, Czech Republic, in 1976. He received the M.Sc. degree in electrical engineering from the Brno University of Technology in 1999. Currently he is a Ph.D. student of the common France – Czech study programme. He is interested in the future systems of mobile communications and wireless local area networks.