

CONTRIBUTION TO THE NEURO-FUZZY CONTROL OF VOLTAGE INDUCTION MACHINE INVERTER FED

M. BENDJEBBAR*, M. ZERIKAT**

*Université des sciences et de la technologie Mohamed BOUDIAF Oran, Faculty of Electrical Engineering
B.P. 1505 El-Mnaouer, Oran 31000 Algeria, E-mail: bendjebb_dz@yahoo.fr

**Ecole Normale Supérieure de l'Enseignement Technique Oran, Departement of Electrical Engineering
B.P. 1523 El-Mnaouer, Oran 31000 Algeria E-mail: zerikat@yahoo.fr

ABSTRACT

This article presents a modern strategy to improve the performance of electrical drives control. The approach used consists of combining both fuzzy and neural control algorithms to make better use of the knowledge resulting from both techniques. The numerical simulation tests carried have shown that the techniques robustness are very good and the obtained results validate the proposed neuro-fuzzy control diagram taking into account the induction motor model complexity due to high non linearity presence.

Keywords: speed control, induction motor, fuzzy logical, neuronal networks, neuro-fuzzy.

1. INTRODUCTION

The advance of power electronics and industrial computing technologies have allowed induction machine to be widely used in variable speed applications. However, the requirements of better performances and the complex model of the induction motor require powerful control algorithms. The estimators enabling to train the non measurable parameters present a good identification of the machine. The recent artificial intelligent algorithms have helped in solving most of non linear control problems. Amongst these techniques, neuro-fuzzy approaches are very interesting not only due to their intrinseque non linear proprieties, but also due to the learning process; which offers them certain ability for adaptative control. The neural networks are mainly characterised by their fast operation and the great ability to approximate non linear dynamics. The fuzzy logic is a technique used to deal with imprecise knowledge based on analogues linguistics to those used in communication. Hence, in a perspective to be able to deal with all types of information came the idea to combine both approaches in order to design neuro-fuzzy control algorithms. This consists of linking known knowledge from fuzzy techniques with that knowledge learnt from neural techniques. In this article, contribution on the study and analysis of voltage fed inverter induction motor robust control is proposed.

We first present a squirrel cage induction motor model to evaluate the model complexity of the machine. We then briefly present reasoning modes related both to fuzzy sets and to neural networks, and also we deal with the adaptative neuro-fuzzy controllers (ANFIS). The obtained simulation results and their interpretations will enable us to conclude that the proposed neuro-fuzzy control applied to inverter fed induction motor for speed variation is a powerful and effective tool that give the induction motor performances the same merits as those obtained from a direct current machines [1], [2].

2. INDUCTION MOTOR MODEL

The mathematical model of the induction machine expressed in equations is given as:

$$\frac{d\omega_r}{dt} = \frac{n_p M}{J L_r} (\psi_{rd} i_{sq} + \psi_{rq} i_{sd}) - \frac{T_L}{J} \quad (1)$$

$$\frac{di_{sd}}{dt} = \frac{M R_r}{\sigma L_s L_r^2} \psi_{rd} + \frac{n_p M}{\sigma L_s L_r} w_r \psi_{rd} - \frac{M^2 R_r + L_r^2}{\sigma L_s L_r^2} i_{sd}$$

$$\frac{di_{sq}}{dt} = \frac{M R_r}{\sigma L_s L_r^2} \psi_{rq} - \frac{n_p M}{\sigma L_s L_r} w_r \psi_{rd} - \frac{M^2 R_r + L_r^2}{\sigma L_s L_r^2} i_{sq} + \frac{1}{\sigma L_s} u_{sq} \quad (2)$$

$$\frac{d\psi_{rd}}{dt} = -\frac{R_r}{L_r} \psi_{rd} - n_p w_r \psi_{rq} + \frac{R_r}{L_r} M i_{sd}$$

$$\frac{d\psi_{rq}}{dt} = -\frac{R_r}{L_r} \psi_{rq} + n_p w_r \psi_{rd} + \frac{R_r}{L_r} M i_{sq} \quad (3)$$

With:

$$\sigma = 1 - \frac{M^2}{L_s L_r} \quad (4)$$

The electromagnetic torque is found as:

$$C_e = \frac{2pM}{3L_r} (i_{sq} \psi_{rd} - i_{rd} \psi_{rq}) \quad (5)$$

3. SPEED REGULATION

3.1. Case of the fuzzy controller

The structure of figure 1 represents the diagram of a fuzzy controller (FLC) [3].

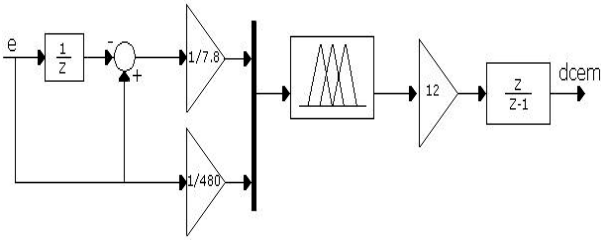

Fig. 1 Structure of a loop of order based on the FLC

3.1.1. Inputs and outputs variables choice

The inputs variables are the error and its differential [5]:

$$e(k) = \omega_{ref} - \omega_m \tag{5}$$

$$de(k) = e(k) - e(k-1) \tag{6}$$

The output variable is the reference torque variation (dcem). It is to be noted that this latter will be integrated to give a reference torque (cem), this torque will be converted to a reference current (Iqs) through the orientation block. Let us note that the inputs are pondered by gains which largely contribute to the response improvement.

3.1.2. Choice of the speech universes

To have flexibility in the implementation of the controller, we must limit the universes of speech of input and output with an interval determined by the standardization of the input and the output i.e. [-1, 1], therefore it is necessary to have profits of adaptation to get wanted dynamics, but there is no systematic technique for the determination of these profits, therefore one proceeds by groupings.

3.1.3. Choice of the membership functions

The selected membership functions have trapezoidal shape at the edges and triangular shape within the speech universes (see figure 2.). We present the rules table as shown in table I.

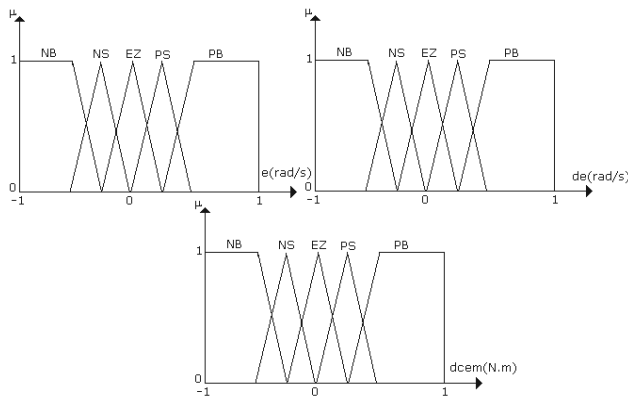

Fig. 2 Membership functions

One can summarize in table I, the rules and their inferences [2], [4] and [5].

Table I counts of the rules

e \ de	NB	NS	EZ	PS	PB
NB	NB	NB	NB	NS	EZ
NS	NB	NB	NS	EZ	PS
EZ	NB	NS	EZ	PS	PB
PS	NS	EZ	PS	PB	PB
PB	EZ	PS	PB	PB	PB

Where the significant of these are: negative big (NB), negative small (NS), equal zero (EZ), positive small (PS) and positive big (PB).

3.2. Case of the neuro-fuzzy controller

The neuro-fuzzy control is based on the combination of both tools, fuzzy systems and neural networks. In this method, we make use of the advantage offered from both techniques. The fuzzy control gives the possibility to manipulate imprecise and uncertain data whereas; the neural networks have adaptative and learning proprieties. [3]

Neuro-fuzzy models are divided into two classes:

- Class 1: One of the applications of this class is the A.N.F.I.S.
- Class 2: the most known it is NEFCON (Neuro Fuzzy CONtroller)

3.2.1. Definition and operation principal

A.N.F.I.S. (adaptive neuro fuzzy inference system) is based on a set of inputs/outputs data where adaptative membership functions are generated. A neural structure similarly to that of the neural networks is used to project input values and output ones by assigning to their membership function which are variables during the learning process. There is the possibility, according to the number existing values to choose a number of membership function, there is a compromise to be made between the number of this later and the learning time from one side and the shape from the other side.

3.2.2. Architectural network ANFIS

Figure 3. illustrates a neural representation of a fuzzy control system, type Sugeno, the network architecture is made of five layers:

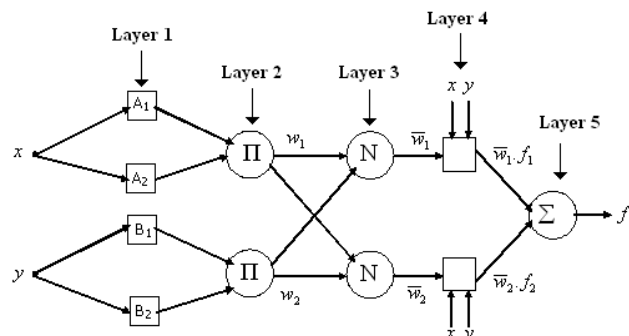

Fig. 3 Two inputs ANFIS network.

- LAYER 1:

They are adaptive neurons (represented by a square). There are the nodal which express membership conditions; they play the role of fuzzification. Each nodal is more or less activated in terms of membership degree to a given subset.

$$S_1^1 = \mu_{\text{Have}}(x) \quad (7)$$

- LAYER 2:

Each neuron on this layer is a fixed neuron (represented by a circle). This last represents a rule; it is connected to the neurons of the preceding layer which are the antecedents of the rule.

$$S_1^2 = W_1 = \mu_{\text{Have}}(x) * \mu_{\text{BI}}(y) \quad (8)$$

S_1^2 : represents the value of i^{th} rule.

- LAYER 3:

For each rule, we associate a fixed neuron (Represented by a circle) which carries out the standardization of the value of truth of the rule. Each neuron of this layer is connected to all the neurons of the preceding layer.

$$S_i^3 = \overline{w_i} = \frac{w_i}{\sum_{j=1}^N w_j} \quad (9)$$

- LAYER 4:

The units of this layer are connected to all those of inputs. The connections of this layer fill the role of the consequence part of the rules (the output of rule), each node i is calculated according to the variables of inputs as follows:

$$S_i^4 = \overline{w_i} f_i = \overline{w_i} (a_i x + b_i y + c_i) \quad (10)$$

With (a_i, b_i, c_i) , the set of the parameters called parameters of the consequences.

- LAYER 5:

The output is obtained by adding the outputs of layer 4.

$$S_i^5 = \sum_i \overline{w_i} f_i \quad (11)$$

3.2.3. Training of network ANFIS

Model ANFIS generally uses the algorithm of retro-propagation of the gradient to modify the parameters of

the functions of membership and the estimate of least square to determine the coefficients of the linear combination in the consequence part of the rule.

Let us consider a system ANFIS with N input, K rules and an output and suppose that the training is done by using p examples. The output of network ANFIS is calculated as follows: [1], [6], [7]

$$f = \frac{\sum_{i=1}^k w_i y_i}{\sum_{i=1}^k w_i} = \sum_{i=1}^k \overline{w_i} (a_0^{(i)} + a_1^{(i)} x_1 + \dots + a_n^{(i)} x_n) \quad (12)$$

$$w_r = \prod_{i=1}^n \mu_{j_r}^{(i)}(x_i) \quad (13)$$

$$\overline{w_r} = \frac{w_r}{\sum_{i=1}^k w_i} \quad (14)$$

The learning algorithm follows the next procedure:

The learning examples are propagated and we determine the $\alpha_1^{(k)}$ by estimating the least squares, with the learning functions parameters of the previous part being fixed. We fixed $\alpha_1^{(k)}$ and we propagate again the examples and we adjust the learning functions parameters by using gradient propagated method. If the error is reduced in the four successive iterations; then we increase the learning rate of training by 10%. If the error is smaller (10^{-5}), we stop the iteration, or we start again from the first step.

4. SIMULATION RESULTS

First of all, we have replaced the classical PI controller by a fuzzy controller described previously; see figures 3.1, 3.2 and 3.3. In the second part, we have tested the neuro-fuzzy controller, described previously; see figures 4.1, 4.2 and 4.3.

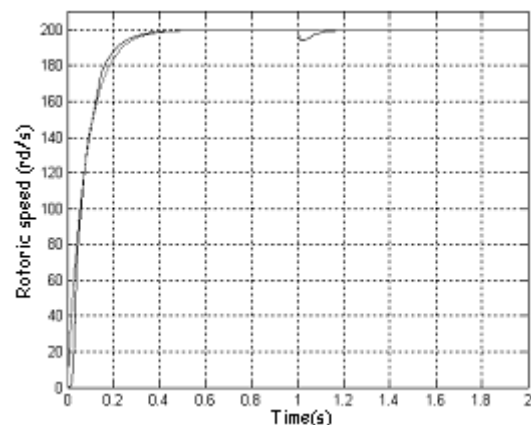

Fig. 3.1 Speed response

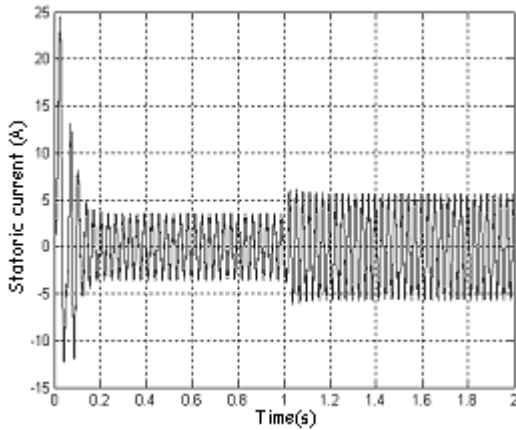

Fig. 3.2 Stator current

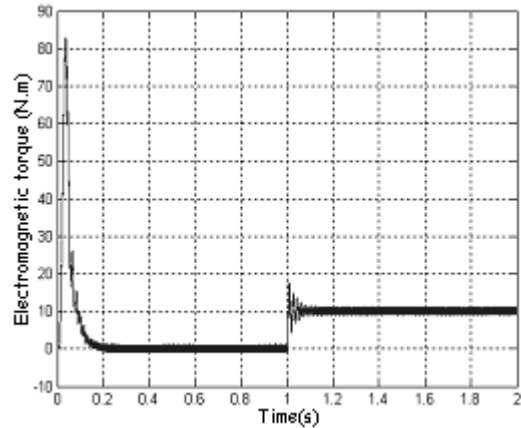

Fig. 4.3 Electromagnetic torque

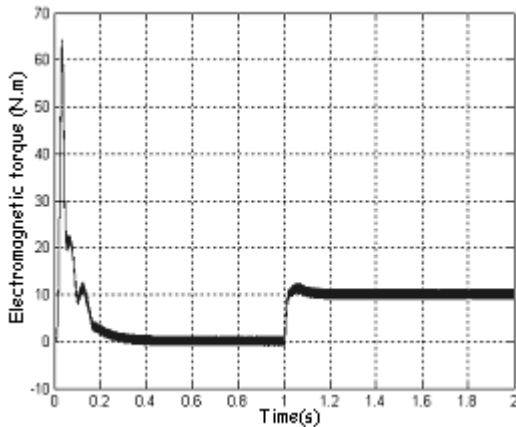

Fig. 3.3 Electromagnetic torque

To illustrate clearly the difference, we have drawn a characteristic wave representing the three modes of control (see figure 5).

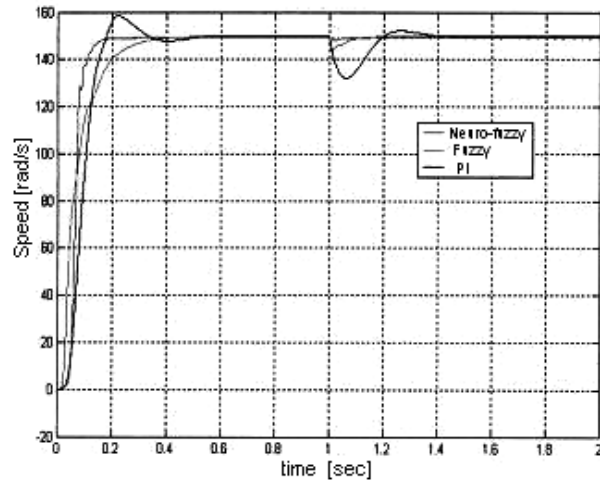

Fig. 5 The various speed curves

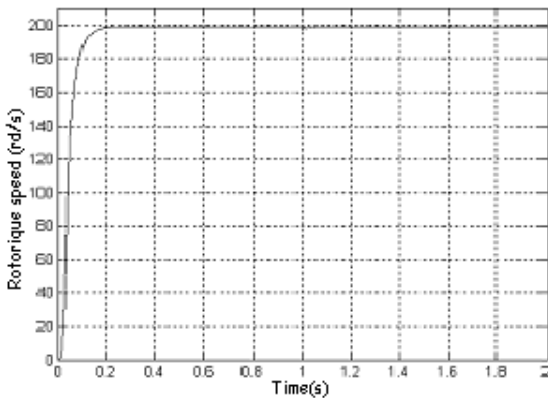

Fig. 4.1 Speed response

5. RESULTS INTERPRETATION

The motor parameters used in this article, are mentioned in appendix. In the different control modes, during one second, we have changed the load torque to see in a better way the robustness of the regulation used.

5.1. Fuzzy control

Figures 3.1, 3.2 and 3.3 represent the speed of rotation, the rotor current and the electromagnetic torque. As far as the speed is concerned, it does not exhibit overshooting when load torque of 10 N.m is applied. The speed falls down then returns back to its reference after a time of 0.1s. For the current, after the transition mode, the current stabilises at the value of 3.5A with the load torque change, the current increase to attain a value of 5.5A where it stabilises. During the transition mode, the torque reaches a value of 70 N.m, after this mode which lasts for 0.15 s, under the load torque application. The torque follows this perturbation with a slight overshoot, then stabilises around the value of 10 N.m.

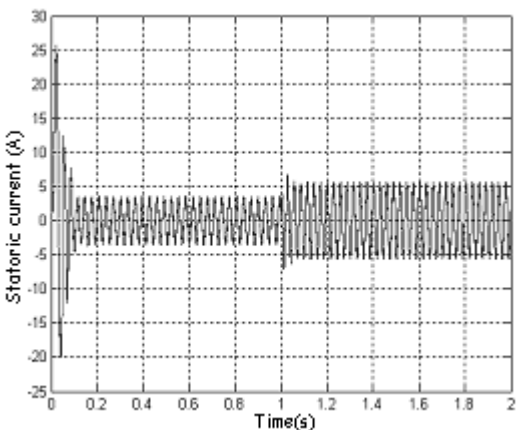

Fig. 4.2 Stator current

5.2. Neuro-fuzzy order

Figures 4.1, 4.2 and 4.3 represent the speed of the rotation, the rotor current and the electromagnetic torque. As far as the speed is concerned, it does not exhibit overshooting due to the application of a 10N.m load torque. The speed decreases then goes back to its reference value for a period of 0.055s. After the transition mode, the current stabilises at a value of 3.5A, then due to load torque change, the current increases to attain a value of 5.7A and then stabilises. During the transition period, the torque reaches a value of 83N.m, after the transition mode, which lasts for 0.115s and due to the load torque application, the torque fluctuates with a slight overshooting, then stabilises around a value of 10N.m. To see better the advantages of the neuro-fuzzy control, figure 5 illustrates well the remarks made, that is, the neuro-fuzzy control is the best compared to other methods.

6. CONCLUSION

This paper presents two new vector control methods of a voltage inverter fed induction motor. Due to the insufficient dynamic performance of PI classical controller, we used as a first step fuzzy controller based essentially on a linguistic synthesis. This latter, was well adapted and gave a noticeable improvement at the transition mode. It can be confirmed that the proposed fuzzy controller enables us not only to obtain satisfactory results with respect to reference signals but also, with respect to perturbation. One should also note that the implementation of this technique does not have yet standard design tools and a general theory frame. As far as the neural networks are concerned, these offer the advantage to by pass the model and adapt themselves to new situations or new cases. It is the reason for which they are employed side by side with fuzzy system. Our second step is then to develop a neuro-fuzzy controller on the basis of the hybrid approach. This work enables us to greatly improve the performance results compared to the classical PI controller or even the fuzzy controller. The results showed a better control of the transition mode of the machine both for overshooting and time response with a perfect decoupling between the rotor flux and electromagnetic torque. An effective reject of the applied load torque and a fast dynamic pursuit of the reference signal it can be noticed. We can then conclude with certainly that the technique provides a better control of the transition mode.

REFERENCES

- [1] Bryds M.A. and Kulawski G.J. (1999): dynamic neuronal controllers for induction motor. - Trans IEEE. Nor. Netw. Vol.10, N°2.
- [2] Kwan C.M. and Lewis F.L. (2000): Robust backstepping neuronal control of induction motors using networks. - Trans IEEE. Nor. Netw., Flight 11, N° 5
- [3] J.S. Jang (1997): neuro-fuzzy and software computing has computational Approach to learning

and machine intelligence, Prentice Hall.

- [4] F Mimouni : speed ordering of an asynchronous motor per neuronal controller, INES 1998/99.
- [5] B Tayeb: use of the networks of neuro-blurs in automatic speech recognitions Thesis of magister 2005, ITO Oran.
- [6] B.Abdelkader, O.Hamza: Application of the networks of neurons to the ordering of an inverter of tension supplying an asynchronous motor. PFE 2000 USTO Oran
- [7] Mr. Mohamed, Mr. Henni : improvement of the performances of the ordering of an asynchronous motor supplied with an inverter of tension PFE 2005 USTO Oran

Appendix

The motor parameters are:

Nominal voltage (V)	220/380
Nominal current (A)	9.4/4.7
Nominal power (kw)	1.5
Number of pairs poles	2
Stator resistance (Ω)	$R_s = 4.85$
Rotor resistance (Ω)	$R_r = 3.805$
Stator leakage inductance (H)	$L_s = 0.274$
Rotor leakage inductance (H)	$L_r = 0.274$
mutual inductance (H)	$M = 0.258$
Inertia moment ($Kg.m^2$)	$J = 0.031$
Friction Coefficient (Nm/rad/s)	$f = 0.00114$
Nominal speed (rpm)	$N_n = 1420$

Received May 6, 2007, accepted August 8, 2008

BIOGRAPHIES

M. Bendjebbar was born on August, 16, 1965 in Relizane Algeria. He received his B.S degree in Electrical Engineering from the University of Sciences and Technology of Oran, Algeria, in 1989, and the M.S degree from the same University of Sciences and Technology of Oran, in 1993. He is currently Professor of Electrical Engineering at the University of Sciences and Technology of Oran. His research interests include Electrical machines and Drives Control, Power Electronics, as well as Intelligent Control.

M. Zerikat received the B.S degree in electrical engineering and the M.S. and PhD degrees in electronics and control systems from the University of Sciences and Technology of Oran, Algeria, in 1982, 1992, and 2002, respectively. Following graduation, he joined the university as a lecturer. He is currently a professor in the department of electrotechnics engineering. His current research includes electrical machines, high-performance motor drives modelling and adaptive control systems, image processing and development of intelligent application. He is actively involved in many projects with industry while engaged in teaching, research and

consulting in the area of artificial intelligence. Actually he is associate Professor at Electrical Engineering Institute (ENSET) of Oran- Algeria. He has authored more than 40 technical papers published in international journals and conference proceedings. He authored a book on Automatic control, which was recently published and

regularly gives tutorials and industrial courses on these subjects. Dr. Zerikat is a chairman of the institute of electrical and electronic engineers in the state of Algeria. He is regularly reviews papers for several journals in his area. He is an active member of the industrial COST Education Committee.