

# MATHEMATICAL DESCRIPTION OF TUNNEL SYSTEMS FOR THE PURPOSE OF DESIGN THE PREDICTIVE ALGORITHM

Jozef HRBČEK, Juraj SPALEK, Vojtech ŠIMÁK

Department of Control and Information Systems, Faculty of Electrical Engineering,  
University of Žilina, Univerzitná 8215/1, 010 26 Žilina, Slovak Republic,  
e-mail: {jozef.hrbcek, juraj.spalek, vojtech.simak}@fel.uniza.sk

## ABSTRACT

*Model Predictive Control (MPC) is an advanced method of process control that has been in use in the process industry such as chemical plants and oil refineries since the 1980s. Model predictive controllers rely on dynamic models of the process, obtained by system identification. In this work a design approach for control of ventilation system in road tunnel by model predictive control algorithm is described. Predictive control seems to be an appropriate approach that can help to improve properties of existing ventilation systems. Advantages of predictive control result mainly from its ability to solve both SISO and MIMO tasks, to have regard for dynamics of process changes in a broad extent, to compensate effect of measurable and non-measurable failures and to formulate the task as an „optimization control task“ considering limiting conditions of control actions, changes of control actions and output variables. We can use identification of the system based on the data obtained from the real ventilation system.*

**Keywords:** predictive control, model, road tunnel, ventilation system

## 1. INTRODUCTION

The road tunnel is a system since a proper algorithm must be used to keep concentrations of harmful pollutants under the certain level. To make a design of the predictive controller possible the existing tunnel system must be identified first using methods for system identification. Since each tunnel is unique, the design must be realized for the particular road tunnel – in this case for the Prague’s road tunnel Mrázovka. Data measured in the control centre of the tunnel are used to create basic types of stochastic parametric models and deterministic models in the programme environment MATLAB. Inputs values are traffic intensity, atmospheric pressure, velocity and output values are CO (carbon monoxide) concentration, NO<sub>x</sub> (oxides of nitrogen) concentration and opacity inside the tunnel [6].

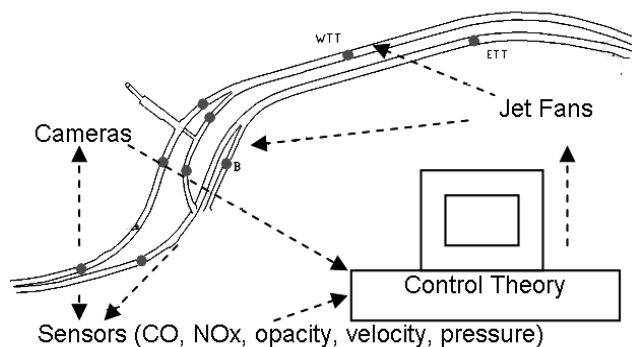

**Fig. 1** Topology of road tunnel and control system

Effects of jet fan operation on concentration of pollutants in the tunnel tube are also subject to identification. The ventilation system represents one function unit designed as longitudinal ventilation with a central efferent shaft and protection system avoiding spread of harmful pollutants into the tunnel surround area. Ventilation is longitudinal facing in direction of traffic with air suction at the south opening of the eastern tube

(ETT) and at the branch B, with air being transferred at the north opening to the western tunnel tube (WTT) (see Fig. 1) [6].

## 2. MODELS OF DYNAMICS SYSTEMS

For the purpose of identification it is interesting to describe the sought process using input-output relations [3]. The general procedure for estimation of the process model consists of several steps: determination of the model structure, estimation of parameters and verification of the model. Finally we can convert the created models to any other usable form.

### 2.1. Stochastic models

Several stochastic models were considered as discussed below. In all of them existence of the stochastic component  $\zeta(t)$  was assumed. Most often we considered  $\zeta$  to be a white noise; however more complex cases are possible too. The stochastic models mentioned below are in discrete area all [3].

The model **ARX** (Auto-Regressive with eXogenous variable) assumes the error appearing as a white noise  $\zeta$  in the equation of the system:

$$Ay = Bu + \xi, \quad (1)$$

where  $A$  and  $B$  are polynomials.

The model **ARMAX** (Auto-Regressive Moving Average with eXogenous Input) assumes the error appearing as the MA model, i.e.

$$Ay = Bu + C\xi, \quad (2)$$

where  $A$  and  $B$  are polynomials in  $z^{-1}$ .

In the case of the model **OE** (Output Error) we suppose that the stochastic component appears as a white noise additive to the output quantity (measurement noise) [3].

$$y = \frac{B}{A}u + \xi ; \quad (3)$$

These models was created to find out the dependence for SISO models, where input was the traffic intensity (i.e. number of vehicles per unit time) and output was the concentration of CO, concentration of NOx and visibility inside the road tunnel. Simulations shows that OE model characterize the tunnel behavior better, because the stochastic components is acting at the output. Two day simulation based on traffic intensity is on the Fig. 2.

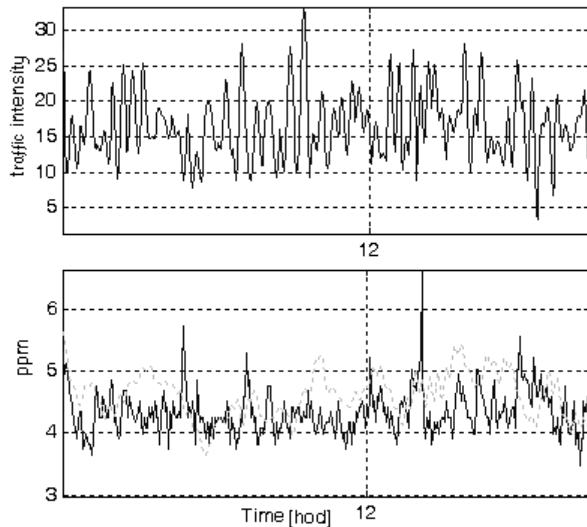

**Fig. 2** Input (traffic intensity), output (CO concentration [ppm] - black line) and simulated data (CO concentration [ppm] - grey dashed line)

The black values are measured data and the grey dashed values are simulated data on the second graph. Although the simulated value is not the same as measured data this result is sufficient for this system with most stochastic behaviour.

## 2.2. Transfer function

A transfer function is a mathematical representation of the relation between the input and output of a (linear time-invariant) system. For Single-input Single-output (SISO) Linear Systems we have the equation 4 [3]:

$$\frac{Y(s)}{U(s)} = G(s) . \quad (4)$$

For Single-input Multiple-output (SIMO) discrete time linear systems we can write the metrics equation for jet fan characteristics:

$$\begin{bmatrix} y_1(k) \\ y_2(k) \\ y_2(k) \end{bmatrix} = \begin{bmatrix} G_{11}(k) \\ G_{21}(k) \\ G_{31}(k) \end{bmatrix} \cdot [u_1(k)] ; \quad (5)$$

The outputs variables are CO concentrations, visibility and NOx concentrations. This model includes the

switching system. The jet fan has the power output about a few mega watts therefore this device shouldn't be switched on for some short time only.

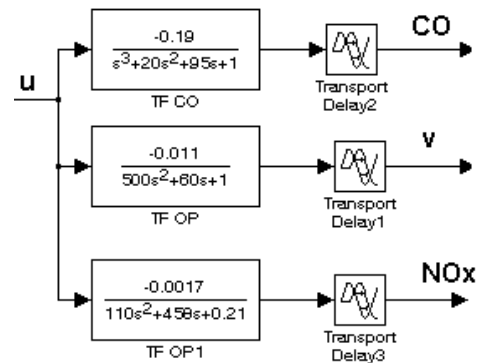

**Fig. 3** Jet fan model in road tunnel tube

Contemporary solution is based on PLCs designed for 4 levels switching system. Since ventilation control system is a critical process, control system must meet safety requirements. About safety requirements is mentioned in [10]. Also we must take into the account a risk analysis and traffic control by variable road signs [14].

## 2.3. State-space model

State-space model can be used to formulate the predictive control problem. The concept of the state of a dynamic system refers to a minimum set of variables, known as state variables that fully describe the system and its response to any given set of inputs. The State-space representation of a linear system with  $p$  inputs,  $q$  outputs and  $n$  state variables is written in the state equations [1]:

$$\dot{\bar{x}}(t) = \bar{A}(t) \cdot \bar{x}(t) + \bar{B}(t) \cdot \bar{u}(t) \quad (6)$$

and output equation is:

$$\bar{y}(t) = \bar{C}(t) \cdot \bar{x}(t) + \bar{D}(t) \cdot \bar{u}(t) \quad (7)$$

where **A** is the "state matrix", **B** is the "input matrix", **C** is the "output matrix" and **D** is the "zero matrix".

We use the State-space model to describe the one separate functional part in road tunnel according to Fig. 4.

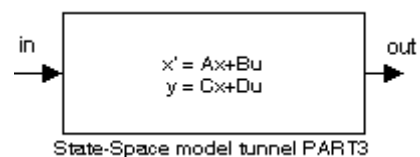

**Fig. 4** Block diagram of the model of road tunnel tube

- In(1) – Traffic intensity of car
- In(2) – Traffic intensity of truck
- In(3) – Velocity
- Out(1) – Concentration of CO

Out(2) – OP-opacity inside the tunnel  
 Out(3) – Concentration of NOx

This model characterizes behavior of tunnel tube and his response to inputs values. Input values are the traffic intensity of car, traffic intensity of truck and their velocity. In the Fig. 5 and Fig. 6 we can see the model response.

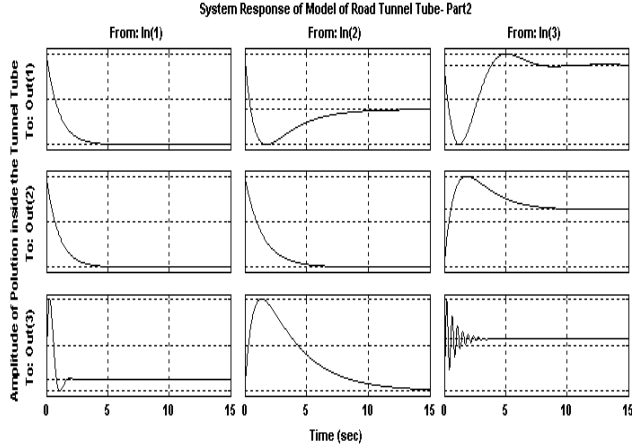

Fig. 5 System response of model (impulse response)

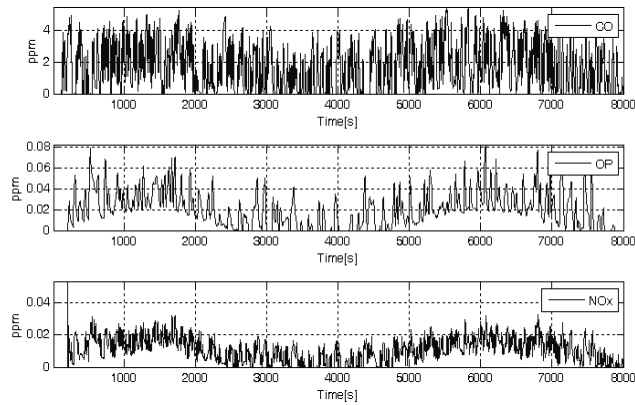

Fig. 6 System response of model – concentration of pollution for two-day traffic

The abbreviation *ppm* is a way of expressing very dilute concentrations of substances. Just as per cent means out of a hundred, so parts per million or ppm means out of a million. It describes the concentration of something in air.

### 3. MODEL VALIDATION

The purpose of model validation is to verify that identified model fulfills the modeling requirements according to subjective and objective criteria of good model approximation. In this work was used several validation methods:

Residuals analysis; Akaike Final Prediction Error (FPE) for estimated model; Model accuracy and parameter accuracy. These methods are explained in [17].

### 4. MODEL PREDICTIVE CONTROL OF VENTILATION SYSTEM

Model Predictive Control Toolbox uses linear dynamic modeling tools. We can use transfer functions, State-space matrices, or its combination. We can also include delays, which are in the real system. The MPC control action at time  $k$  is obtained by solving the optimization problem:

$$\min \left\{ \Delta u(k|k), \dots, \Delta u(m-1+k|k), \right. \\ \left. \varepsilon \left[ \sum_{i=0}^{p-1} \left( \sum_{j=1}^{n_y} |w_{i+1,j}^u (y_j(k+i+1|k) - r_j(k+i+1))|^2 \right. \right. \right. \\ \left. \left. \left. + \sum_{i=1}^{n_u} |w_{i,j}^{\Delta u} \Delta u_j(k+i|k)|^2 + \sum_{i=1}^{n_u} |w_{i,j} (u_j(k+i|k) - u_{j,target}(k+i))|^2 \right) \right] \right. \\ \left. + \rho_\varepsilon \varepsilon^2 \right\}, \quad (8)$$

where the subscript "( $j$ )" denotes the  $j$ -th component of a vector, " $(k+i|k)$ " denotes the value predicted for time  $k+i$  based on the information available at time  $k$ ;  $r(k)$  is the current sample of the output reference, subject to

$$u_{j,min}(i) - \varepsilon V_{j,min}^u(i) \leq u_j(k+i|k) \leq u_{j,max}(i) + \varepsilon V_{j,max}^u(i); \\ \Delta u_{j,min}(i) - \varepsilon V_{j,min}^{\Delta u}(i) \leq \Delta u_j(k+i|k) \leq \Delta u_{j,max}(i) + \varepsilon V_{j,max}^{\Delta u}(i); \\ y_{j,min}(i) - \varepsilon V_{j,min}^y(i) \leq y_j(k+i+1|k) \leq y_{j,max}(i) + \varepsilon V_{j,max}^y(i), \\ \text{where } i = 0, \dots, p-1; \\ \Delta u(k+h|k) = 0, h = m, \dots, p-1, \varepsilon \geq 0 \quad (9)$$

with respect to the sequence of input increments  $\{\Delta u(k|k), \dots, \Delta u(m-1+k|k)\}$  and to the slack variable  $\varepsilon$ , and by setting  $u(k)=u(k-1)+\Delta u(k|k)$ , where  $\Delta u(k|k)$  is the first element of the optimal sequence. Note that although only the measured output vector  $y_m(k)$  is fed back to the MPC controller,  $r(k)$  is a reference for all the outputs. When the reference  $r$  is not known in advance, the current reference  $r(k)$  is used over the whole prediction horizon, namely  $r(k+i|k)=r(k)$  in Equation 8.

In Model Predictive Control the exploitation of future references is referred to as anticipative action (or look-ahead or preview). A similar anticipative action can be performed with respect to measured disturbances  $v(k)$ , namely  $v(k+i)=v(k)$  if the measured disturbance is not known in advance (e.g. is coming from a Simulink block) or  $v(k+i)$  is obtained from the workspace. In the prediction,  $d(k+i)$  is instead obtained by setting  $n_d(k+i)=0$ . The  $w^{\Delta u}_{ij}$ ,  $w^u_{ij}$ ,  $w^y_{ij}$ , are nonnegative weights for the corresponding variable. The smaller  $w$ , the less important is the behavior of the corresponding variable to the overall performance index. And  $u_{j,min}$ ,  $u_{j,max}$ ,  $\Delta u_{j,min}$ ,  $\Delta u_{j,max}$ ,  $y_{j,min}$ ,  $y_{j,max}$  are lower/upper bounds on the corresponding variables. The constraints on  $u$ ,  $\Delta u$ , and  $y$  are relaxed by introducing the slack variable  $\varepsilon \geq 0$ . The weight  $\rho_\varepsilon$  on the slack variable  $\varepsilon$  penalizes the violation of the constraints. The larger  $\rho_\varepsilon$  with respect to input and output weights, the more the constraint violation is penalized. The Equal Concern for the Relaxation vectors  $V_{min}^u, V_{max}^u, V_{min}^{\Delta u}, V_{max}^{\Delta u}, V_{min}^y, V_{max}^y$  have nonnegative entries which represent the concern for relaxing the corresponding constraint; the larger  $V$ , the softer the constraint.  $V=0$

means that the constraint is a hard one that cannot be violated. [4]

The MATLAB environment is used to simulate behaviour of the system according to the Fig. 7. It is a closed-loop control (regulation) system with limitations imposed to control quantity and outputs. It uses MPC mode format and solves optimization problem with the use of quadratic programming. The pollutant concentration should be kept within the allowable limit (for CO, 75 ppm or less).

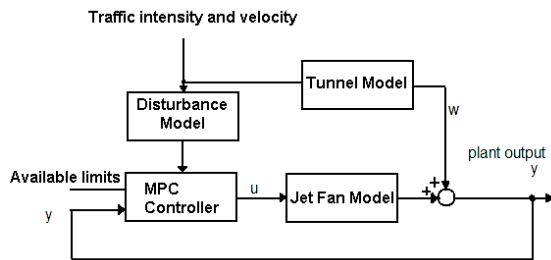

Fig. 7 Closed-loop control of ventilation using a predictive controller

We can choose the prediction horizon  $P$  and the control horizon  $M$ . The output constraints were set to 6, because this is the maximum input for three pairs of jet fans corresponding with real system. Weight tuning is the essential task to set the controller. In Fig. 8 we can see the results.

## 5. SIMULATIONS AND RESULTS

The Fig. 8 had shown the simulation results for designed model Predictive controller. The presented simulation results are obtained for the following

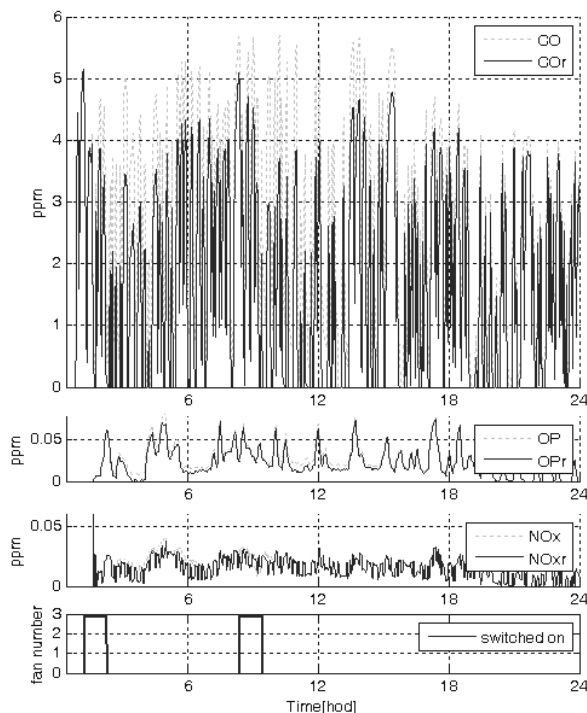

Fig. 8 Simulated values of pollution inside the tunnel with (black line) and without (grey dashed line) MPC controller and fan number (number of acting jet fans)

concentration limits: 5 ppm for CO concentrations, 0.06 ppm for visibility concentrations and 0.05 ppm for NOx concentrations.

The grey dashed lines represent the concentrations of pollution without using the controller. They are named CO, OP and NOx. The black lines represent the concentrations of pollution with using the controller. They are named CO<sub>r</sub>, OP<sub>r</sub> and NO<sub>xr</sub>. We can see how affect the ventilation system to reduce the pollution. In this paper we pointed out only to concentration of CO, because this type of pollution is most dangerous for human organism. Opacity and concentration of NOx is below the dangerous limits. The jet fans were switched on two times per days for chosen limits. The final model may be described as hybrid system including the discrete event system description [7].

## 6. CONCLUSION

The paper presents a methodology that has been used for design the models of road tunnel ventilation system. This is the model of one separate functional part of road tunnel in Prague. Data characterizing the existing ventilation system was used to analyze and identify the system and create its models. Thereafter the predictive control of ventilation was designed enabling to predict concentrations of pollutants and optimize system operation. Model of a multi-dimensional system from one week data has been created and verified in MATLAB environment. This part is the ground for best design of ventilation control system. Predictive controller was designed and simulated. Model predictive controller is a perfect candidate to be used to reduce effectively the values of pollution inside the road tunnel tube. The next work will include the disturbance model as computed predicted values of pollution. This may provide the best results to optimise the repeated switching of the jet fans.

## ACKNOWLEDGMENTS

This work has been partially supported by the Grant Agency VEGA of the Slovak Republic, grant No. 1/0023/08; "Theoretical apparatus for risk analysis and risk evaluation of transport telematic systems and the project No. 26220120028; "Centre of excellence for systems and services of intelligent transport".



## REFERENCES

- [1] CAMACHO, E. F. – BORDONS, C.: *Model Predictive Control*. 2nd ed., Springer-Verlag London Limited, 2004, 405 p., ISBN 1-85233-694-3.
- [2] MACIEJOVSKI, J. M.: *Predictive Control with constraints*, 2002, 331 p., ISBN 0-201-39823-0.

- [3] JOHANSON, R.: *System modeling and identification*, Prentice-Hall, 1993, 512 p., ISBN 0-13-482308-7.
- [4] Help in programme MATLAB7.
- [5] HRBČEK, J.: *Active Control of Rotor Vibration by Model Predictive Control – a simulation study*, In: Report 153, Picaset Oy, Helsinki 2007, ISSN 0356-0872.
- [6] PAVELKA, M. – PŘIBYL, P.: *Simulation of Air Motion and pollutions inside the Road Tunnel – Mathematical Model*, OPTUN 228/06-EEG (2006).
- [7] ZELENKA, J. – MATEJKA, T.: Aplikácia teórie diskretných udalostných systémov na analýzu a modelovanie reálneho výrobného systému. (The application of discrete event systems theory for the real manufacturing system analysis and modeling.), In: Proceedings of the conference of cybernetics and informatics 2010, Vyšná Boca 2010, ISBN 978-80-227-3241-3.
- [8] NOSKIEVIČ, P.: *Modelování a identifikace systémů. (Systems modeling and identification.)*, Ostrava: MONTANEX, a.s., 1999, 276 p., ISBN 80-7225-030-2.
- [9] GODAN, J. at al.: *Tunnels, Road Tunnels and Railway Tunnels*, 2001, p. 202, 135882/p-UK/Z.
- [10] ŽDÁNSKY, J. – RÁSTOČNÝ, K. – ZÁHRADNÍK, J.: Problems Related to the PLC Application in the Safety Systems, No. 2(6) 2008, pp. 109–116, ISSN 1818–5509.
- [11] CASSANDRAS, Ch. G. – LAFORTUNE, S.: *Introduction to Discrete Event Systems*. Kluwer Academic Publishers, 1999, ISBN 0-7923-8199-8.
- [12] BUBNICKI, Z.: *Modern Control Theory*. Springer, 2005, 422 p., ISBN 3-540-23951-0.
- [13] The MathWorks, Inc.: *Control System Toolbox*, 2006, Natick, MA 01760-2098 USA.
- [14] PŘIBYL, P. – JANOTA, A. – SPALEK, J.: *Analýza a řízení rizik v dopravě. Pozemní komunikace a železnice. (Analysis and risk control in transport. Highway and railway.)*, BEN Praha, ISBN 80-7300-214-0.
- [15] LEWIS, P. – YANG, Ch.: *Basic Control Systems Engineering*, 1997, Prentice-Hall, ISBN 0-13-597436-4.
- [16] TAMMI, K.: *Active control of radial rotor vibrations*, Picaset Oy, Helsinki 2007, VTT, ISBN 987-951-38-7007-2.
- [17] HRBČEK, J.: *Parametric Models of Real System and the Validation Tools*, In: Proc. 8th European Conference of Young Research and Science Workers in Transport and Communications technology. pp. 93–96, Žilina, June 22 – 24, 2009, ISBN 978-80-554-0027-3.

Received January 4, 2010, accepted April 22, 2010

## BIOGRAPHIES

**Jozef Hrbček** (M.Sc., PhD.) was born in Ružomberok, Slovakia, in 1981. In 2004 he graduated (M.Sc.) at the department of Control and Information Systems of the Faculty of Electrical Engineering at University of Žilina. He completed his PhD. studies in 2008; his thesis title was “Predictive control of the critical process”. Since 2008 he is working at the Department of Control and Information systems. His scientific research is focusing on control systems.

**Juraj Spalek** (assoc. prof., PhD.) was born on 1953. In 1976 he received his MSc. from the Department of Interlocking, Signalling and Communications at the Faculty of Mechanical and Electrical Engineering of the Technical University of Transport and Communications in Žilina. His PhD thesis (1981) entitled “Electronic logical system as interlocking system” concerned the area of safety engineering. His research and pedagogical interests include reliability engineering, fuzzy-set theory applications, analysis of reliability and safety of electronic systems for safety-related critical applications e.g. intelligent transport systems. In 1993 he worked out his second doctoral thesis “Electronic systems properties in critical applications”. At the present he works as an professor and a head of the Department of Control and Information Systems at the Faculty of Electrical Engineering of the University of Žilina.

**Vojtech Šimák** (Ing., PhD.) was born on 6.12.1980. In 2004 he graduated (M.Sc.) at the department of Control and Information Systems of the Faculty of Electrical Engineering at University of Žilina. He defended his PhD in the field of automation in 2008; his thesis title was “Computer vision utilisation in autonomous vehicle control”. Since 2009 he is working as a teacher at the Department of Control and Information Systems. His scientific research is focusing on image segmentation.