

# PERFORMANCE ANALYSIS OF MC-CDMA SYSTEMS USING CHAOTIC AND CONVENTIONAL SPREADING SEQUENCES

Henrieta PALUBOVÁ, Pavol GALAJDA

Department of Electronics and Multimedia Communications, Faculty of Electrical Engineering and Informatics,  
Technical University of Košice, Letná 9, 042 00 Košice, Slovak Republic,  
tel.: +421 55 602 4108, e-mail: palubova@orangemail.sk

## ABSTRACT

Performance evaluation and comparison of multi-carrier code division multiple access (MC-CDMA) system model for usually used spreading sequences (Golay, Zadoff-Chu, Gold) with chaotic sequences (generated by improved logistic map, by chaotic map with different slopes and by tent function) at the presence of Saleh and Rapp model of high power amplifier (HPA) is investigated. Rayleigh channel model and AWGN channel model is used in this simulation. Nonlinear amplification of HPA introduces degradation of bit error performance and destroys the orthogonality among subcarriers. In order to avoid performance degradation without requiring extremely large backoffs in the transmitter amplifier, it becomes convenient to use nonlinear multi-user detection techniques at the receiver side for all spreading sequences. To illustrate this fact, microstatistic multi-user receiver (MSF-MUD) and conventional minimum mean square error receiver (MMSE-MUD) are considered and mutually compared. The results of analyses are based on computer simulations. The best performance for Rayleigh channel model we can obtain when we used the Golay or Chaotic sequences in combination with MSF-MUD or MMSE-MUD, with using 8-PSK modulation type.

**Keywords:** MC – CDMA, Saleh model, Rapp model, Chaos, Pseudorandom sequence, Multi – user receivers

## 1. INTRODUCTION

Spread spectrum techniques have been used in wire and wireless communication [14]. Sequences derived from chaotic phenomena are actively being considered for spread-spectrum communications [15]. In last decade there has been an increasing amount of interest in chaotic sequences in multiple access systems. One major difference between chaotic sequences and another type of Pseudorandom Number (PN) sequences is that chaotic sequences are not binary. Therefore the main advantages of their usage are increased security of the transmission and also ease of generation and visualization of great number of sequences [24]. Generation of chaos is described in [22, 23, 25], Direct Sequence Spread Spectrum (DSSS) CDMA with chaotic sequences is described for example in [14], Direct Sequence (DS) CDMA is described in [15-21] and MC/DS CDMA is described in [4]. Chaos is a deterministic, random-like process found in non-linear dynamical system, which is non-periodical, non-converging and bounded. Moreover, it has a very sensitive dependence upon its initial condition and parameters. Chaotic signals can be used in communication systems [26]. This paper is dealing with chaotic sequences in MC CDMA system. The generation of orthogonal sequences is utmost importance in these systems, in order to increase the spectrum efficiency in multirate communications systems. In CDMA, sets of non-correlated sequences with good autocorrelation and crosscorrelation properties are also required in order to provide low interference between users [12].

Section 2 describes introduction to chaotic sequences, section 3 deals with MC – CDMA system model, section 4 describes nonlinear models and section 5 describes the performance analysis of the MC – CDMA system using of spreading sequences.

## 2. CHAOTIC SEQUENCES

The pseudo-noise sequences such as Gold, Golay, Zadoff-Chu and Walsh Hadamard are the most popular spreading sequences that have good correlation properties. However generators of these pseudorandom sequences can generate the finite number of states for several users. On the other hand a chaotic sequence generator can visit an infinite number of states in a deterministic manner and therefore produce a sequence which never repeats itself [4]. In this section the three types of chaotic sequences are described. The first one is generated by improved logistic map, the second one is generated from chaotic map with different slopes and the third one is generated by tent function.

A chaotic map is a discrete-time dynamical system

$$x_{k+1} = f(x_k), \quad 0 < x_k < 1, \quad k = 0, 1, 2, \dots \quad (1)$$

running in chaotic state. The chaotic sequence

$$\{x_k : k = 0, 1, 2, \dots\} \quad (2)$$

can be used as spread-spectrum sequence in place of PN sequence in conventional Direct-Sequence, Spread-Spectrum and Multi-carrier (DS/SS/MC) CDMA communication systems. Chaotic sequences are uncorrelated when their initial values are different, so in chaotic spread-spectrum systems, each user has the different initial value.

### 2.1. Chaotic map with different slopes

The chaotic sequence (shown in Fig. 2) with biased values ( $q$  and  $r$ ), when initial value  $x_k = 0.2$  is used. It was done from the Bernoulli shift map (Fig. 1) described by:

$$x_{k+1} = \begin{cases} \frac{(1+r)x_k + q + r}{1-q} & (-1 \leq x_k \leq -q) \\ \frac{(1-r)x_k + q}{q} & (-q < x_k \leq 0) \\ \frac{(1-r)x_k - q}{q} & (0 < x_k \leq q) \\ \frac{(1+r)x_k - q - r}{1-q} & (q < x_k \leq 1) \end{cases} \quad (3)$$

The slopes of the map can be changed by making a decision parameters  $q$  ( $0.5 \leq q \leq 1.0$ ) and  $r$  ( $0.0 \leq r \leq 1.0$ ).

As an example, chaotic sequence with biased values  $q$  and  $r$  equal 0.5 and 0.1 respectively is shown in Fig. 2.

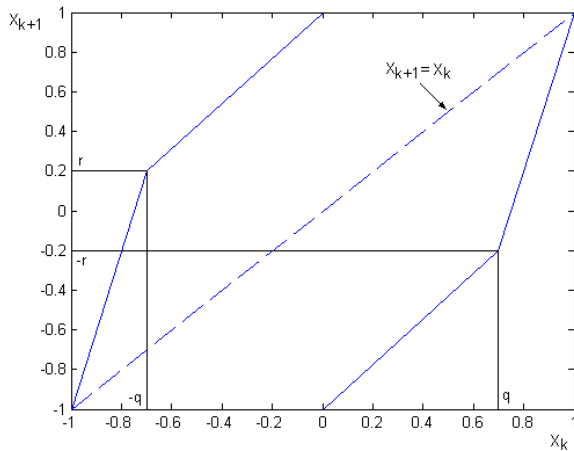


Fig. 1 Chaotic map with different slopes

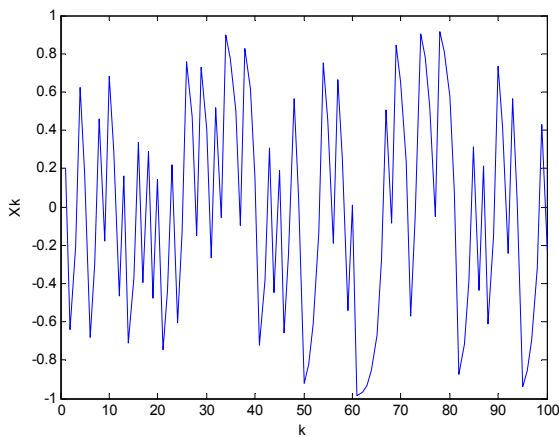


Fig. 2 Chaotic sequences with biased values  $(q,r) = (0.5, 0.1)$  and initial value  $x_k = 0.2$

2.2. The tent function

The tent function is the next example of chaos used in our simulation. The chaotic sequence generated by tent function [6] is described by:

$$x_{k+1} = f(x_k) = \begin{cases} \frac{2x_k + 1 - a}{a + 1} & -1 \leq x_k \leq a \\ \frac{2x_k - 1 + a}{a - 1} & a \leq x_k \leq 1 \end{cases} \quad (4)$$

where  $a \in [-1,1], x \in [-1,1]$

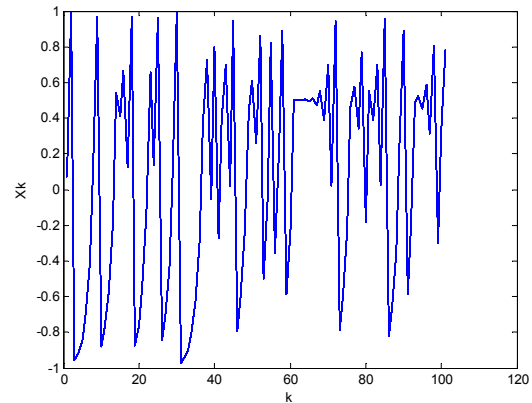


Fig. 3 Chaotic sequence generated by tent function ( $x_k = 0.075, a = 0.5$ )

As an example, chaotic sequence generated by tent function, where parameter  $a = 0.5$  and initial value  $x_k = 0.075$  is shown in Fig. 3.

2.3. Improved logistic map

Improved logistic-map is defined by [1]:

$$x_{k+1} = f(x_k) = 1 - 2(x_k)^2, \quad x_k \in (-1,1) \quad (5)$$

The chaotic sequence:

$$\{x_k : k = 0, 1, 2, \dots\} = \{f^k(x_0) : k = 0, 1, 2, \dots\}, \quad (6)$$

generated by improved logistic-map (Fig. 4), is neither periodic nor converging and sensitively dependent on initial value (initial value is set to  $x_k = 0.2$  and  $x_k = 0.25$  depicted by solid and dotted line, respectively).

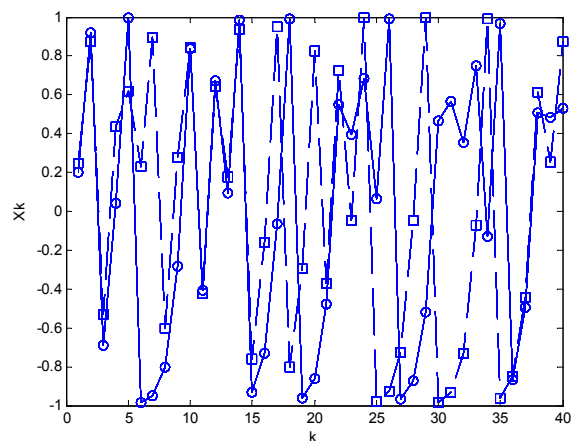


Fig. 4 Chaotic sequences generated by improved logistic map for different initial values

2.4. Characteristic and properties of chaotic sequences

The chaotic sequence is random-like, so probability and statistics can be used for defining to their characteristics [1].

The average of chaotic sequence is equal to 0 and is defined by:

$$\bar{x} = \lim_{N \rightarrow \infty} \frac{1}{N} \sum_{i=0}^{N-1} x_i = \int_0^1 x \rho(x) dx = 0 \tag{7}$$

where  $\rho(x)$  is a density function which does not depend on initial value. The auto-correlation function of chaotic sequence is

$$ac(m) = \lim_{N \rightarrow \infty} \frac{1}{N} \sum_{i=0}^{N-1} (x_i - \bar{x})(x_{i+m} - \bar{x}) = \int_0^1 x f^m(x) \rho(x) dx - \bar{x}^2 = \begin{cases} 1 & (m = 0) \\ 0 & (m \neq 0) \end{cases} \tag{8}$$

If two chaotic sequences begin with different values  $x_{10}$  and  $x_{20}$  are not overlapping, the cross-correlation function of these two sequences is

$$cc_{12}(m) = \lim_{N \rightarrow \infty} \frac{1}{N} \sum_{i=0}^{N-1} (x_{1i} - \bar{x})(x_{2(i+m)} - \bar{x}) = \int_0^1 \int_0^1 x_1 f^m(x_2) \rho(x_1, x_2) dx_1 dx_2 - \bar{x}^2 = 0 \tag{9}$$

From these properties we know, that the chaotic sequences are identical with white noise whose average is zero [1].

To select the proper parameter of different type of chaotic sequences we can use the bifurcation diagram. Bifurcation diagram shows the possible long-term values (equilibria/fixed points or periodic orbits) of a system as a function of a bifurcation parameter in the system. It is usual to represent stable solutions with a solid line and unstable solutions with a dotted line. The example of bifurcation diagram for chaotic map with different slopes is shown in Fig. 5, where the initial value  $x_k = 0.2$ ,  $r$  is set to 0.1 and  $q$  is a bifurcation parameter ( $0.5 \leq q \leq 1.0$ ).

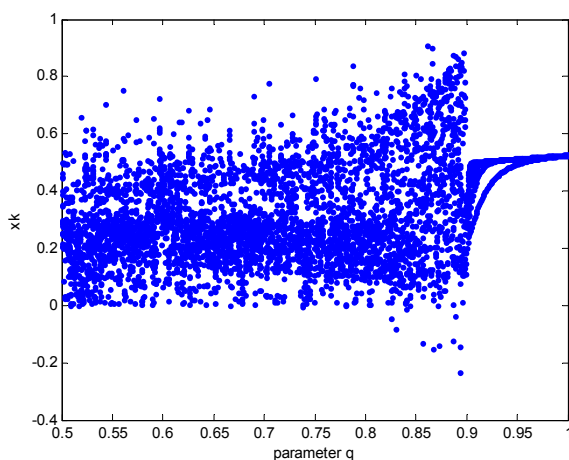


Fig. 5 Bifurcation diagram for chaotic map with different slopes ( $x_k = 0.2, r = 0.1$ )

The chaotic sequences have the excellent statistical parameters [14] and they are orthogonal, which is shown in our simulations.

### 3. MC-CDMA SYSTEM MODEL

In MC-CDMA, instead of applying spreading sequences, in the time domain, we can apply them in the frequency domain, mapping a different chip of a spreading sequence to an individual Orthogonal Frequency Division Multiple Access (OFDM) subcarrier. Hence each of OFDM subcarrier has a data rate identical to the original input data rate and the multicarrier system absorbs the increased rate due to spreading in wider frequency band.

In MC-CDMA transmitter, the information bits to be transmitted by a particular user, are firstly base-band modulated into some modulation symbols and then are spread by using a specific spreading sequence  $c_m$ . The spread symbols are modulated by multi-carrier modulation implemented by IFFT (Inverse Fast Fourier Transform) operation. The IFFT after parallel-to-serial conversion represents the input signal of a HPA (High Power Amplifier). A block diagram of the simplified baseband model of MC-CDMA transmitter is given in Fig. 6 [7]. The receiver consists of serial-to-parallel converter, FFT (Fast Fourier Transform), BMF (receiver-Bank of Matched Filters), block of linear or non-linear transformation (labelled as T) and a decision device. The basic structure of the receivers considered in this paper is sketched in Fig. 7 [7]. Here, the operation of a single-user receiver known as BMF consists of a set of simple matched filters (correlators). In order to extend BMF into a multi-user receiver, the T-transformation block is included in the receiver structure [8]. In this paper, the linear MMSE-MUD [9] as well as nonlinear MSF-MUD for MC-CDMA [10], [11] are considered. The T-transformation block in MMSE-MUD is represented by multi-channel linear Wiener filter. In the case of MSF-MUD, the T-transformation block is represented by a complex valued-multichannel nonlinear microstatistic filter (C-M-CMF) [8].

The main benefit of combining OFDM with DS-spreading is that it is possible to prevent the obliteration of certain subcarriers by deep frequency domain fades [2].

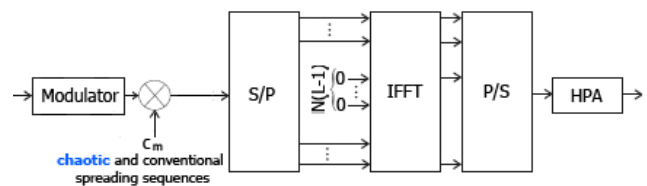


Fig. 6 MC CDMA transmitter

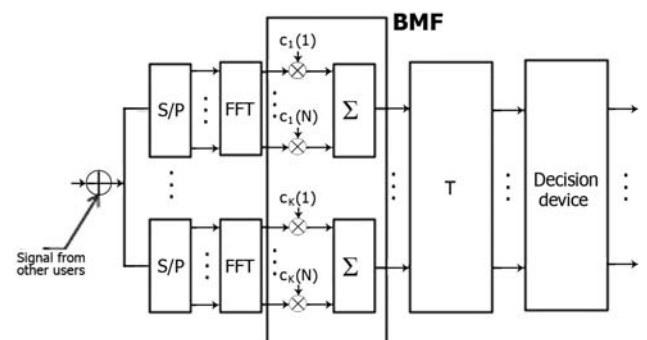


Fig. 7 MC CDMA receiver

#### 4. NONLINEAR MODELS OF POWER AMPLIFIER

There are two major types of power amplifiers used in communications systems:

- Traveling wave tube amplifiers (TWTA)
- Solid state power amplifiers (SSPA)

A common characteristic of both devices is that the signal at their output is a nonlinear function of the input signal [3]. The output  $y(t)$  of the nonlinear amplifier is given by

$$y(t) = F(|x(t)|) \exp(j\Phi(|x(t)|) + j \arg(x(t))) \quad (10)$$

where  $|x(t)|$  is the amplitude (nonnegative voltage envelope) of  $x(t)$ ,  $\arg(x(t))$  is the phase of  $x(t)$ ,  $F(\bullet)$  is the amplitude-to-amplitude (AM/AM) conversion and  $\Phi(\bullet)$  is the amplitude-to-phase (AM/PM) conversion [13]. AM/AM is given for Saleh Model as

$$G(u_x) = \frac{\kappa_G u_x}{1 + X_G u_x^2} \quad (11)$$

and AM/PM as

$$\Phi(u_x) = \frac{\kappa_\Phi u_x^2}{1 + X_\Phi u_x^2} \quad (12)$$

where  $\kappa_G = 2$ ,  $X_G = \kappa_\Phi = 1$  and  $X_\Phi = \pi/3$ . The Saleh model is commonly used for TWTA modelling [27].

AM/AM is given for Rapp Model as

$$G(u_x) = \frac{\kappa_G u_x}{\left(1 + \left(\frac{u_x}{O_{sat}}\right)^{2s}\right)^{\frac{1}{2s}}} \quad (13)$$

and AM/PM as

$$\Phi(u_x) = 0 \quad (14)$$

where  $\kappa_G = O_{sat} = 1$  and  $s = 3$ . The Rapp model is commonly used for SSPA modelling [27].

The AM/AM and AM/PM are nonlinear characteristics where the nonlinearity depends on position of the operating point.

The operating point of the amplifier is defined by input back-off (IBO) parameter, which is determined by the ratio between the saturation power of the amplifier and the average power of the input signal. Hence the IBO is given as

$$IBO = 10 \log_{10} \left( \frac{P_{max, in}}{P_x} \right) \quad [dB] \quad (15)$$

The measure of effects due to nonlinear HPA could be decreased by the selection of relatively high value of IBO.

The HPA operation in the region of its nonlinear characteristic causes a nonlinear distortion of transmitted signal that subsequently results in higher BER and out of band energy radiation [27].

#### 5. COMPARISON OF THE CHAOTIC AND ANOTHER TYPE OF PN SEQUENCES

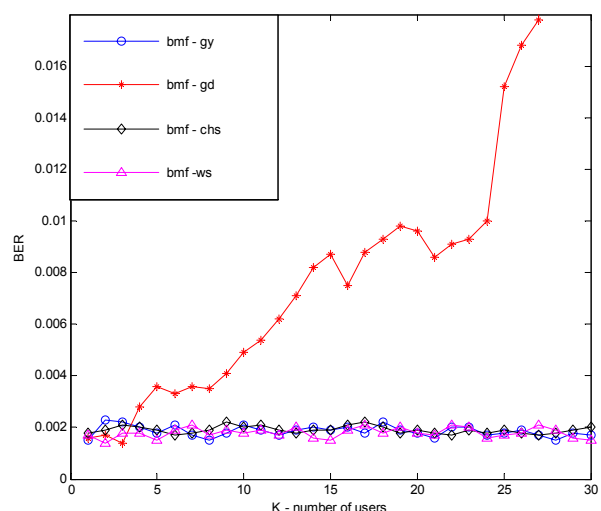
MC-CDMA performance analysis presented in this section is based on computer simulations. The basic scenario of the simulations is represented by the uplink MC-CDMA transmission system performing through AWGN and Rayleigh transmission channel, at 16-QAM, 8-PSK or 16-PSK baseband modulation, for  $K$  active users ( $K = 1 - 30$ ).

As the spreading sequences, Walsh codes (ws), Gold codes (gd) with period of 32 chips as well as complementary Golay (gy) codes and Chaotic sequences (chs) with period of 31 chips have been applied. The total number of sub-carriers has been set to  $N = 128$ . In order to avoid the aliasing and the out-of-band radiation into the data bearing tones, the oversampling rate of 4 has been applied [7]. Then,  $N_u = 32$  (for Walsh codes and Gold codes) and  $N_u = 31$  (for complementary Golay codes and Chaotic sequences) carriers per transmitted block have been used for the spread of 16-QAM, 8-PSK and 16-PSK symbol transmission. The three types of systems are simulated here. The first one is the linear MC-CDMA system, the second one is the nonlinear MC-CDMA system with Saleh model of HPA and the third one is the nonlinear MC-CDMA system with Rapp model of HPA.

##### 5.1. Linear MC-CDMA System

The number of 100 000 input bits, and the modulation type of 16-QAM, 8-PSK and 16-PSK was used for simulations.

In the Fig. 8 and Fig. 9, BER vs.  $K$  users for MC-CDMA transmission system for different spreading sequences, modulation 8-PSK, Rayleigh channel and  $E_b/N_0 = 10$  are given. In Fig. 8 and Fig. 9 are introduced simulations for BMF and MSF receiver, respectively.

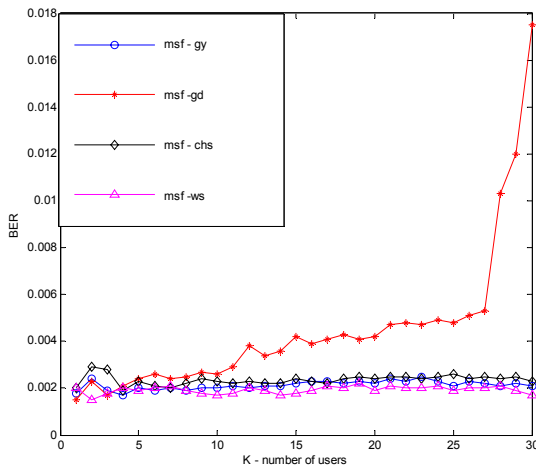


**Fig. 8** BER vs.  $K$  users for MC-CDMA transmission system for different spreading sequences, modulation 8-PSK, Rayleigh channel,  $E_b/N_0 = 10$  and BMF receiver

It can be seen from Fig. 8, that all the types of sequences have the same properties except of Gold sequences that have the worse properties for more users.

From Fig. 9 it can also be seen, that again all the types of sequences have the same properties except Gold sequences, which have the worst properties especially for more than 26 users.

The both type of channel AWGN and Rayleigh were simulated. This paper presents the properties only for Rayleigh channel, because it is more realistic. The AWGN channel model has the similar properties than the Rayleigh channel model, but has the lower BER. 16-QAM and 16-PSK modulation has the similar properties as 8-PSK.



**Fig. 9** BER vs.  $K$  users for MC-CDMA transmission system for different spreading sequences, modulation 8-PSK, Rayleigh channel,  $E_b/N_0 = 10$  and MSF receiver

**5.2. Nonlinear MC-CDMA System with Saleh model of HPA**

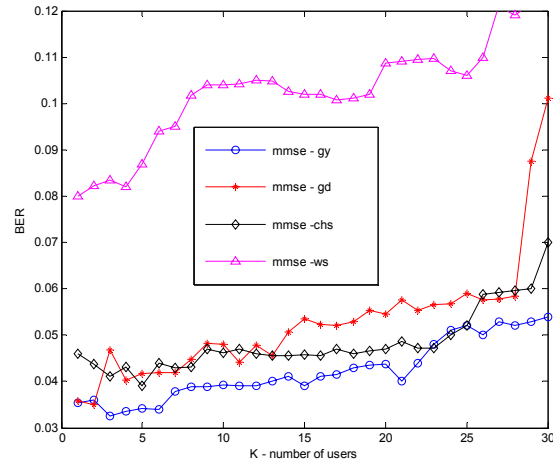
For the specification of the Saleh model of HPA, the parameters  $k_G = 2$ ,  $\chi_G = \chi_\Phi = 1$  and  $k_\Phi = \pi/3$  have been chosen. The Saleh nonlinearity type has very destructive effect on QAM modulation (Fig. 12) [13].

The number of 100 000 input bits, the number of  $K=1-30$  users and the modulation type of 8-PSK or 16-PSK were used for the simulations. In the Fig. 12, the signal constellations of 16-QAM at the outputs of BMF for  $E_b/N_0 = 12$  dB are given.

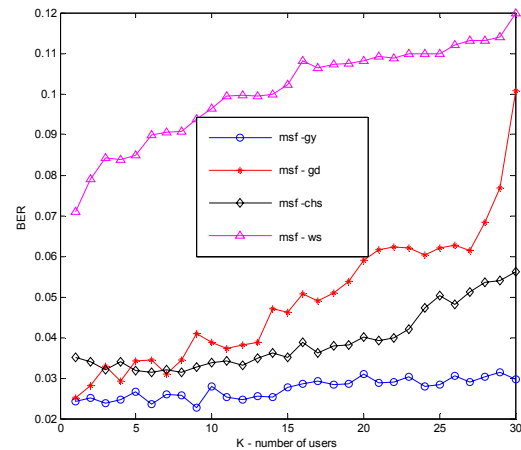
In the Fig. 10-11, BER vs.  $K$  users for MC-CDMA transmission system for different spreading sequences, modulation 16-QAM, Rayleigh channel,  $E_b/N_0 = 10$ , Saleh model and IBO = 4 are given. In Fig. 10 and Fig. 11 are introduced simulations for MMSE and MSF receiver, respectively. The BMF receiver is not used in nonlinear system, because it is the linear receiver and for the nonlinear system it is not suitable because of its high BER.

It can be seen from Fig. 10 and Fig. 11, that the Walsh sequences have the worst properties for nonlinear MC-CDMA system with Saleh model. Chaotic and Golay sequences have the similar properties. Gold sequences have once again for more users the worse properties than chaotic or Golay sequences.

The both type of channel AWGN and Rayleigh were simulated. From simulations it is known that, the AWGN

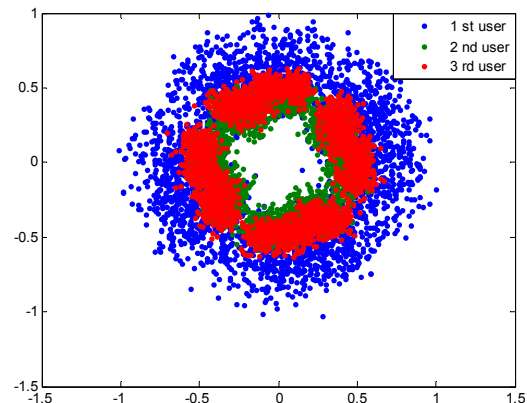


**Fig. 10** BER vs.  $K$  users for MC-CDMA transmission system for different spreading sequences, modulation 16-QAM, Rayleigh channel,  $E_b/N_0 = 10$ , Saleh model, IBO = 4 and MMSE receiver



**Fig. 11** BER vs.  $K$  users for MC-CDMA transmission system for different spreading sequences, modulation 16-QAM, Rayleigh channel,  $E_b/N_0 = 10$ , Saleh model, IBO = 4 and MSF receiver

channel model has the similar properties than the Rayleigh channel model, but has the lower BER. 8-PSK and 16-PSK modulation has the better properties than 16-QAM. Because of worse nonlinearity of Saleh model of HPA the better performance have MSF receiver in compare with MMSE receiver.



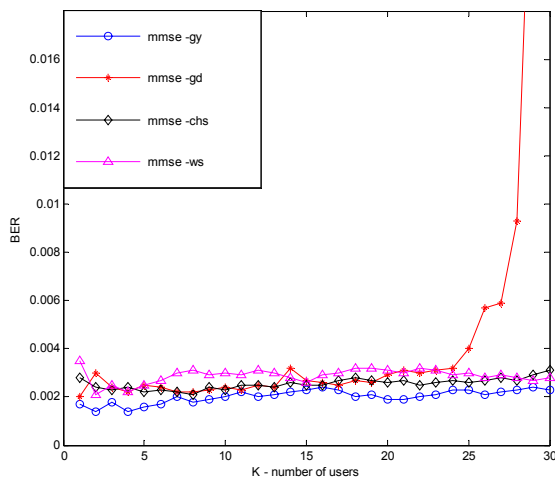
**Fig. 12** Signal constellation of 16-QAM at the output of BMF - Saleh model for chaotic sequences

### 5.3. Nonlinear MC-CDMA System with Rapp model of HPA

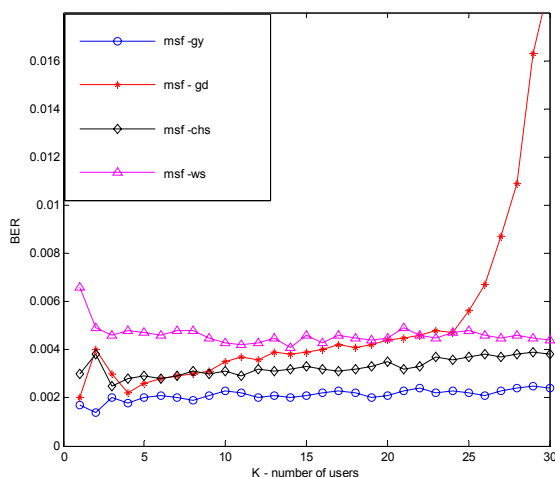
For the specification of the Rapp model of HPA, its parameters  $k_G = O_{sat} = 1$  and  $s = 3$  have been chosen.

The number of 100 000 input bits, the number of users  $K = 1-30$  and the modulation type of 16-QAM and 8-PSK was used in the simulation. In the Fig. 15, the signal constellations of 16-QAM at the outputs of BMF for  $E_b/N_0 = 12$  dB are given. It can be seen from this figure, that this type of nonlinearity doesn't have destructive effect on QAM modulation as it was in case of nonlinear MC-CDMA system with Saleh model (Fig. 12).

In the Fig. 13 and 14, BER vs.  $K$  users for MC-CDMA transmission system for different spreading sequences, modulation 16-QAM, Rayleigh channel,  $E_b/N_0 = 10$ , Rapp model and IBO = 1 are given. In Fig. 13 and Fig. 14 are introduced simulations for MMSE and MSF receiver, respectively.



**Fig. 13** BER vs.  $K$  users for MC-CDMA transmission system for different spreading sequences, modulation 8-PSK, Rayleigh channel,  $E_b/N_0 = 10$ , Rapp model, IBO = 1 and MMSE receiver

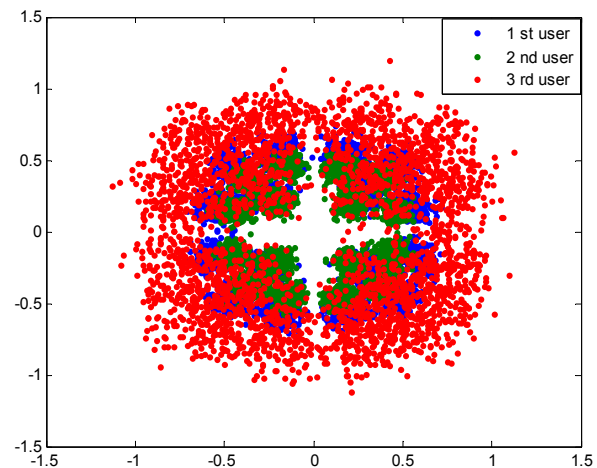


**Fig. 14** BER vs.  $K$  users for MC-CDMA transmission system for different spreading sequences, modulation 8-PSK, Rayleigh channel,  $E_b/N_0 = 10$ , Rapp model, IBO = 1 and MSF receiver

It can be seen from Fig. 13, that the all types of sequences have once again the same properties except Gold sequences, which have the worst properties for more users and extremely worst for more than 26 users.

It can be seen from Fig. 14, that the chaotic sequences and the Golay sequences have the similar properties. The worst properties have the Walsh sequences for a few users and the Gold sequences for more than 26 users.

From simulations it is known, that the AWGN channel model has the similar properties than the Rayleigh channel model, but has the lower BER. 16-QAM and 16-PSK modulation has the worst properties than 8-PSK. Because of better linearity of Rapp model of HPA the performance of MSF and MMSE receivers is similar.



**Fig. 15** Signal constellation of 16-QAM at the output of BMF - Rapp model for chaotic sequences

## 6. CONCLUSION

In this paper, the performance of the MC-CDMA transmission system for two different models of HPA (Saleh and Rapp model), the different spreading sequences, different receiver types and modulations is investigated. It has been found that Saleh model of HPA introduces much higher nonlinear distortion and causes more significant degradation of MC-CDMA transmission system performance than that of Rapp model. The best performance we can obtain when we used the Golay sequences in combination with MSF-MUD or MMSE-MUD. Chaotic sequences have a little bit worse performance than the best Golay sequences. But the big advantage of chaotic sequences is that in theory we can generate an infinite number of states of chaotic sequences which never repeat themselves, however generator of Golay sequences can generate the finite number of states. MMSE-MUD and MSF-MUD have equivalent performance in linear and less nonlinear MC-CDMA system. The worse performance we can obtain for Gold or Walsh sequences. The BER is extremely high for more than 26 users for Gold sequences. When we compare the modulation type, the best performance has 8-PSK. 16-QAM and 16-PSK have the similar performance.

## ACKNOWLEDGMENTS

This work was supported by the project VEGA 1/0045/10 - Advanced Signal Processing Techniques for Reconfigurable Wireless Sensor Network (Nové metódy spracovania signálov pre rekonfigurovateľné bezdrôtové senzorové siete) (30%).

This work is also the result of the project implementation Development of the Center of Information and Communication Technologies for Knowledge Systems (project number: 26220120030) supported by the Research & Development Operational Program funded by the ERDF (70%).

## REFERENCES

- [1] HAI, W. – JIANDONG, H.: “Chaotic Spread – Spectrum Communication Using Discrete – Time Synchronization”, *The Journal of China Universities of Posts and Telecommunications*, Vol. 4, No. 1, June 1997.
- [2] <http://wireless.per.nl/reference/chaptr05/cdma/rake.htm>, Rake receiver in CDMA
- [3] PIJOAN VIDAL, J. L. – HERRAIZ, M. D.: “On OFDM Systems with Low Sensitivity to Nonlinear Amplification”, *Presentation COST 289*, 2002–2007.
- [4] NAGARAJAN, V. – DANANJAYAN, P. – NITHYANANDHAN, L.: “On the Performance of Chaotic Spreading Sequence MIMO MC/DS – CDMA Systems Using NPGP”, *International Conference on Control, Automation, Communication and Energy Conservation*, June 2009.
- [5] ARAI, S. – NISHIO, Y.: “Research on Differential Chaos Shift Keying Changing Deviation of Chaotic Sequence”, *2007 RISP International Workshop on Nonlinear Circuits and Signal Processing*, Shanghai Jiao Tong University, Shanghai, China, Mar. 2007.
- [6] RAZÍM, M. – ŠTECHA, J.: “Nelineární systémy“, *ČVUT Praha*, 1997.
- [7] DROTÁR, P. – GAZDA, J. – KOCUR, D. – GALAJDA, P.: “Effects of Spreading Sequences on the Performance of MC-CDMA System with Nonlinear Models of HPA“, *Radioelektronika*, 2008, 18th International Conference.
- [8] KOCUR, D. – ČÍŽOVÁ, J. – MARCHEVSKÝ, S.: “Nonlinear Microstatistic Multi-User Receiver”, *Acta Electrotechnica et Informatica*, 2003, Vol. 3, No. 3, pp. 10–15.
- [9] HANZO, L. – MUNSTER, M. – CHOI, B. J. – KELLER, T.: “OFDM and MC CDMA for Broadband Multi-User Communications”, *WLANs and Broadcasting*, John Willey & Sons, Ltd, England, 2003.
- [10] KRAJŇÁK, J. – DEUMAL, M. – PAVELKA, P. – KOCUR, D. – GALAJDA, P. – PIJOAN, J. L.: “Multiuser Detection of Nonlinearly Distorted MC-CDMA Symbols by Microstatistic Filtering”, *Wireless Personal Communications*, Oct. 2008, Vol. 47, No. 1, pp. 147–160.
- [11] KRAJŇÁK, J. – PAVELKA, P. – GALAJDA, P. – KOCUR, D.: “Efficient Design Procedure of Microstatistic Multi-User Detector for Nonlinearly Distorted MC-CDMA”, In *Proceedings of 17<sup>th</sup> International Conference Radioelektronika 2007*, Brno (Czech Republic), 2007, pp. 147–152.
- [12] SANDOVAL–MORANTES, D. – MUNOZ–RODRIGUEZ, D.: “Chaotic Sequence for Multiple Access“, *IEE Electronics Letters Online*, No: 19980132, November 1997.
- [13] CHANG, L. Ch. – KROGMEIER, J. V.: “Power Optimization of Nonlinear QAM System with Data Predistortion“, *14th IST Mobile and wireless Communications Summit*, Dresden, Germany, June 2005.
- [14] SAIGUI, H. – YONG, Z. – JIANDONG, H. – LIU, B.: “A Synchronous CDMA System using Discrete Coupled – Chaotic Sequence”, *IEEE* 1996.
- [15] SUNEEL, M.: “Chaotic Sequences for Secure CDMA”, *Ramanujan Institute for Advanced Study in Mathenatics*, Chennai 600005, February 6–8, 2006.
- [16] CONG, L. – SHAOQIAN, L.: “Chaotic Spreading Sequences with Multiple Access Performance Better Than Random Sequences”, *IEEE Transactions on Circuits and Systems I: Fundamental Theory and Applications*, Vol. 47, No. 3, March 2000.
- [17] JEMAA, Z. B. – MARCOS, S. – BELGHITH, S.: “Performance of the Super Stable Orbits based Spreading Sequences in a DS – CDMA System with a MMSE receiver”, *14th European Signal Processing Conference (EUSIPCO 2006)*, Florence, Italy, September 4–8, 2006, copyright by EURASIP.
- [18] MAZZINI, G. – SETTI, G. – ROVATTI, R.: “Chaotic Complex Spreading Sequences for Asynchronous DS – CDMA – Part 1: System modeling and results”, *IEEE Transactions on Circuits and Systems I: Fundamental Theory and Applications*, Vol. 44, No. 10, October 1997.
- [19] VITALI, S. – ROVATTI, R. – SETTI, G.: “On the Performance of Chaos-based multicode DS-CDMA Systems”, *Circuits Systems Signal Processing*, Vol. 24, No. 5, 2005, pp. 475–495.
- [20] ROVATTI, R. – MAZZINI, G. – SETTI, G.: “On the Ultimate Limits of Chaos-based Asynchronous DS-CDMA-I: Basic Definitions and Results”, *IEEE Transactions on Circuits and Systems I: Regular Papers*, Vol. 51, No. 7, July 2004.
- [21] MAZZINI, G. – SETTI, G. – ROVATTI, R.: “Chaotic Complex Spreading Sequences for Asynchronous DS – CDMA – Part 2: Some Theoretical Performance Bounds”, *IEEE Transactions on Circuits and Systems I: Fundamental Theory and Applications*, Vol. 45, No. 4, April 1998.
- [22] GUZAN, M.: “Použitie MATLABu pri analýze obvodov generujúcich chaos“, *Mezindzinárodná konferencie Technical Computing Prague 2009*, November 19, 2009, ISBN 978-80-7080-733-0, 10 pp.

- [23] GUZAN, M. – SOBOTA, B.: “Visualization of Chaos”, *Journal of Electrical and Electronics Engineering*, 2, 1, 2009, pp. 48–51, ISSN 1844-6035.
- [24] HEIDARI-BATANI, G. – MCGILLEM, C. D.: “A Chaotic Direct-Sequence Spread-Spectrum Communication System”, *IEEE Transactions on Communications*, Vol. 42, No. 2/3/4, February/March/April 1994, pp. 1524–1527.
- [25] PARKER, T. – CHUA, L. O.: “Chaos: A Tutorial for Engineers”, *Proc. of IEEE*, 75(8), August, 1987 (special issue).
- [26] KENNEDY, M. P. – ROVATTI, R. – SETTI, G.: “Chaotic Electronics in Telecommunications”, CRC Press LLC, Boca Raton London, New York, Washington D. C., 2000 N. W. Corporate Blvd.
- [27] GUPTA, A. – REEDER, J.: “Nonlinearity Induced Interference Cancellation in OFDM Systems”, *Chalmers University of Technology, Göteborg, Sweden*, 2006, Report No. EX018/2006.

Received January 3, 2011, accepted April 15, 2011

## BIOGRAPHIES

**Henrieta Palubová** was born on 1976 in Kráľovský Chlmec (Slovakia). She received her Ing. (M.Sc.) degree in Electronics and Telecommunications in 2001 from the Faculty of Electrical Engineering and Informatics, Technical University of Košice and she is currently Ph.D. student at the same university. Her research interests include MIMO and multi-carrier mobile communication systems and chaos.

**Pavol Galajda** was born on 1963. He received the M.Sc. degree in electrical engineering from Faculty of Electrical engineering, Technical University (TU) of Košice and PhD. degree in radioelectronics from Faculty of Electrical Engineering and Informatics (FEI), TU of Košice, in 1986 and 1995, respectively. At present he is an associated professor at the Department of Electronics and Multimedia Communications, FEI TU of Košice. His research interests are in nonlinear systems and communications and include chaos, multicarrier communications and software defined radio.